



# Recessed

## VersaForm

2'x2', 4000 lm  
CRI 90 3500K



Project: \_\_\_\_\_  
 Spec Type: \_\_\_\_\_  
 Catalog No: 4122DxxxL9BD \_\_\_\_\_  
 Qty \_\_\_\_\_  
 Line Notes: \_\_\_\_\_

Specifically designed to blend high performance LED technology with versatile options to suit any area, VersaForm allows you to enjoy the latest LED energy efficiencies in concert with your unique style, and as your needs evolve, it's simple to change or upgrade with our unique detachable light engine.

### Ordering guide

Product Type	Version	Configuration	Light Source *	CRI/CCT	Lumens *	Housing	Wiring †	Voltage	Driver
4122		ST	L		D				
VersaForm 2'x2'	D1 Standard T Grid D2 Slot T Grid A1 Air Return on Standard T Grid A2 Air Return on Slot T Grid S1 Discrete Surface Mount	ST Standalone	L LED	8C CRI 80 3000K 8B CRI 80 3500K 8A CRI 80 4000K 9B CRI 90 3500K	E 3000 lm D 4000 lm	S Standard C Chicago Plenum	7 1 cct Dimming N 1 cct Dimming + EM Batt Pack T 1 cct Step Dimming	1 120V 2 277V 3 347V	E Philips Advance 0-10V (1% dim)

\* Nominal values within a range. Consult photometry data for color temp, lumens & distribution of chosen configuration.  
 † Not all wiring types are available with all configurations. Consult Philips Ledalite for a complete list of available options.

### Upgrades & Accessories Please indicate with check mark.

- Drywall Kit Trim Mount
- Flex Whip

### Integrated Controls Please indicate with check mark.

- Response Daylight Single Zone (DS)



# VersaForm

2'x2', 4000 lm

CRI 90 3500K

## Optical System

The optical frame assembly consists of integrated LED arrays edge lighting a light guide panel in order to deliver uniform controlled light through a lower lens. The optical frame ends are constructed from die-formed cold-rolled steel, assembled together with extruded aluminum profiles in a sturdy frame. The frame is hinged (side marked) to allow easy access to the inside of the fixture. Maintenance can be performed from below the ceiling.

## Finish

Housing and frame painted, high quality, powder coated matte white only.

## Housing

Die-formed, post painted, 22 gauge cold-rolled steel. Wire entrance with additional knock-out available on top side for electrical connections.

## Weight

Maximum 28lbs (2x4); 21lbs (1x4); 15lbs (2x2).

## Electrical

Factory pre-wired with driver safety disconnect.

## Mounting

**Recessed:** Fixtures can be fastened directly to the T-bar grid and/or tied-off to the building structure. Optional drywall kit trim mount can be fastened to a wood frame or with hangar wire. Continuous row mounting not available with drywall kit trim mounts.

**Surface:** Fixtures can be mounted over recessed junction box and side entry also available.

## Standard Driver

Philips Advance Xitanium 0-10V, 1-100%, Class 2 rated output. Consult Philips Ledalite for other available drivers.

## Standard Battery Pack

Philips Bodine, 90 min, 10W, Class 2 rated output, Emergency lumen output = 10W x luminaire efficacy x 1.1. Typical output: 1100lm.

## Lumen Maintenance

LEDs have been tested by the manufacturer in accordance with IESNA LM-80-08. At an ambient temperature of 25°C, the LED lumen maintenance expectation according to IES TM-21-11 is:

L90 (9k) >54,000 hrs (**Reported** methodology).

L80 (9k) 145,000 hrs (**Projected** methodology).

## Source Color

LEDs rated for color rendering CRI >80, R9 >0 and fixture to fixture color accuracy within 2 SDCM.

## Controls

Available with the following integrated controls:

Response daylight sensor (for single zone).

## Wiring

**Recessed:** Optional flex whips are supplied in 6' lengths.

**Surface:** Standard wiring configurations available.

## Approvals

Certified to UL, CSA, and IES standards. City of Chicago Approved CCEA (housing option C). Certain versions without battery packs are DesignLights Consortium® qualified. Please see the DLC QPL list for exact catalog numbers ([www.designlights.org/QPL](http://www.designlights.org/QPL)).

## Warranty

Five-year luminaire limited warranty including LED boards and driver.

USA: <http://www.usa.lighting.philips.com/support/support/warranty>

Canada: <http://www.lighting.philips.ca/support/support/warranty>

## Environment

Rated for dry & damp locations in operating ambient temperatures of 0-25°C (32-77°F). Many luminaire components, such as reflectors, refractors, lenses, and LEDs are made from various types of plastics which can be adversely affected by airborne contaminants. If sulfur based chemicals, petroleum based products, cleaning solutions, or other contaminants are expected in the intended area of use, consult factory for compatibility. Damage caused by sulfur, chlorine, petroleum based solution or other contaminants are not covered under warranty.

Due to continuing product improvements, Philips Ledalite reserves the right to change the specifications without notice.

## Options and Details

### Mounting

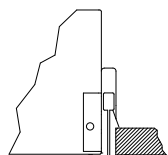

9/16" 24mm Tee D1 option

#### D1 Standard T-Grid

Option D1 works with 9/16" and 15/16" flat T-grid ceilings. It can also be used with slot T-grid ceilings, but it will not sit flush with the bottom of the T-bar.

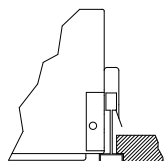

9/16" 14mm Bolt Slot Tee D2 option

#### D2 Slot T-Grid

Option D2 is designed to sit close to flush with slot T-grid ceilings and some tegular tile ceiling types.

#### Air Return

Air return is available with the VersaForm 2'x2' & 2'x4' options. Vent area is finished in black.

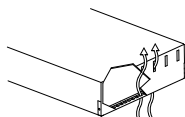

### Cross Section

Cross Section

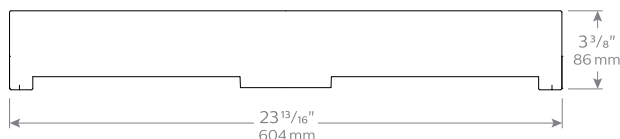

Housing

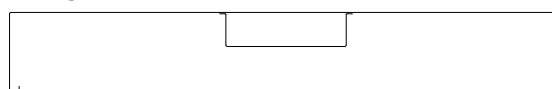

Light Engine

# VersaForm

2'x2', 4000 lm  
CRI 90 3500K

## Photometry - 3500K

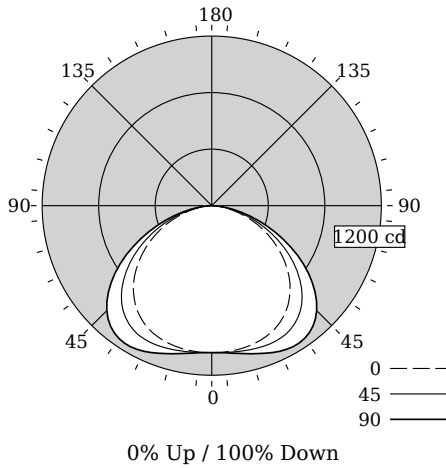

## Candela Distribution

Vertical Angle	Horizontal Angle					Zonal Lumens
	0	22.5	45	67.5	90	
0	1040	1040	1040	1040	1040	0
5	1040	1041	1042	1044	1045	100
15	1026	1035	1055	1075	1085	299
25	991	1011	1060	1114	1137	491
35	914	944	1021	1107	1146	641
45	783	816	904	1003	1050	700
55	602	630	707	792	837	635
65	402	419	468	526	554	468
75	202	211	233	261	276	251
85	46	47	50	55	59	61
90	0	0	0	0	0	0
95	0	0	0	0	0	0
105	0	0	0	0	0	0
115	0	0	0	0	0	0
125	0	0	0	0	0	0
135	0	0	0	0	0	0
145	0	0	0	0	0	0
155	0	0	0	0	0	0
165	0	0	0	0	0	0
175	0	0	0	0	0	0
180	0	0	0	0	0	0

Fixture photometry has been conducted in accordance with IESNA LM-79-08

IES files for this and other photometric options can be downloaded online at [www.lightingproducts.philips.com](http://www.lightingproducts.philips.com)

## Coefficients of Utilization (%)

RCR	Ceiling												
	70	50	30	10	70	50	30	10	70	50	30	10	0
0	119	119	119	119	116	116	116	111	111	111	111	100	0
1	109	104	99	96	106	101	98	97	94	91	83	83	0
2	98	90	83	77	96	88	82	85	79	75	69	69	0
3	89	79	70	64	87	77	69	74	67	62	58	58	0
4	82	69	60	53	79	68	60	65	58	52	49	49	0
5	75	62	52	46	73	61	52	58	51	45	42	42	0
6	69	55	46	40	67	54	46	52	45	39	36	36	0
7	64	50	41	35	62	49	41	48	40	34	32	32	0
8	59	45	37	31	58	45	36	43	36	30	28	28	0
9	55	41	33	27	54	41	33	40	32	27	25	25	0
10	52	38	30	25	50	38	30	37	29	24	22	22	0

## Avg. Luminance (cd/m2)

Vertical Angle	Horizontal Angle		
	0	45	90
55	3410	4003	4737
65	3085	3593	4254
75	2535	2926	3458
85	1719	1858	2184

## Distribution Summary

Hemisphere	0% Up / 100% Down
Spacing Along (0 °)	1.36
Spacing Across (90 °)	1.63

Philips Ledalite



**Light Output (Lumens)** 3644

**Watts** 43.9

**Lumens per Watt (Efficacy)** 83

---

**Color Accuracy** 92

Color Rendering Index (CRI)

---

**Light Color** 3341 (Bright White)

Correlated Color Temperature (CCT)

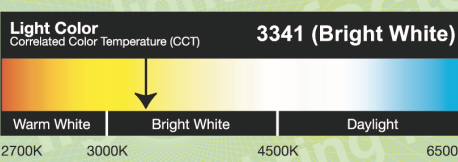

Warm White | Bright White | Daylight

2700K | 3000K | 4500K | 6500K

---

**Warranty\*\*** Yes

All results, except LED Lumen Maintenance, are according to IESNA LM-79-2008: Approved Method for the Electrical and Photometric Testing of Solid-State Lighting. The U.S. Department of Energy (DOE) verifies product test data and results.

\*\* See [www.lightingfacts.com/products](http://www.lightingfacts.com/products) for details.

Registration Number: F46Z-SIWE2T (7/11/2014)  
Model Number: 4x22xxxL9BD  
Type: Luminaire - Troffer/Grid Ceiling

# VersaForm

2'x2', 4000 lm  
CRI 90 3500K

## Optical Performance

Flux (lm)	3645
Efficacy (lm/W)	83.0
Power (W)	43.9
CCT (K)	3341
CRI	92
R9	76
x	0.4156
y	0.3978
Duv	0.0010

## Electrical Performance - 3500K

Input Voltage	120V	277V	347V
Input Power	43.9W	43.4W	42.2W
Input Current	0.37A	0.17A	0.12A
Power Factor	0.990	0.926	0.977
Total Harm. Distortion	12.9%	18.1%	9.0%

Tested values . contact technical support for rated values. Off-state power zero unless certain controls are specified.

