

Unlock your vision

VERSAFORM
2'X2' LED



DIRECT, BEAM SHAPING LIGHT GUIDE WITH STEPPED DIFFUSER
2'x2', 4000 lm 3000K

Project: _____

Spec Type: _____

Catalog No: 4122DxxxL8CD

Qty _____

Line Notes: _____



Ordering guide

Product Type	Version	Configuration	Light Source *	CRI/CCT	Lumens *	Housing	Wiring †	Voltage	Driver
<input type="text" value="4122"/>	<input type="text"/>	<input type="text" value="ST"/>	<input type="text" value="L"/>	<input type="text"/>	<input type="text" value="D"/>	<input type="text"/>	<input type="text"/>	<input type="text"/>	<input type="text"/>
VersaForm 2'x2' LED	D1 Standard T Grid D2 Slot T Grid A1 Air Return on Standard T Grid A2 Air Return on Slot T Grid S1 Discrete Surface Mount	ST Standalone	L LED	8C CRI 80 3000K 8B CRI 80 3500K 8A CRI 80 4000K 9B CRI 90 3500K	E 3000 lm D 4000 lm	S Standard C Chicago Plenum	1 1 cct 5 1 cct + EM Batt. Pack 7 1 cct Dimming N 1 cct Dimming + EM Batt. Pack T 1 cct Step Dimming	1 120V 2 277V 3 347V	E Philips Advance

* Nominal values within a range. Consult photometry data for exact color temp, lumens & distribution.
 † Not all wiring types are available with all configurations. Consult Philips Ledalite for a complete list of available options.

Upgrades & Accessories Please indicate with check mark.

- Drywall Kit Trim Mount
- Flex Whip

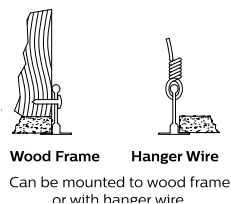
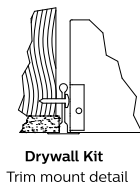

Integrated Controls Please indicate with check mark.

- Response Daylight Sensor Single Zone (DS)
- Philips Actilume Occupancy Sensor (DO) (includes field commissionable daylight sensor)



VERSAFORM

2'X2' LED

DIRECT, BEAM SHAPING LIGHT GUIDE WITH STEPPED DIFFUSER

Photometry

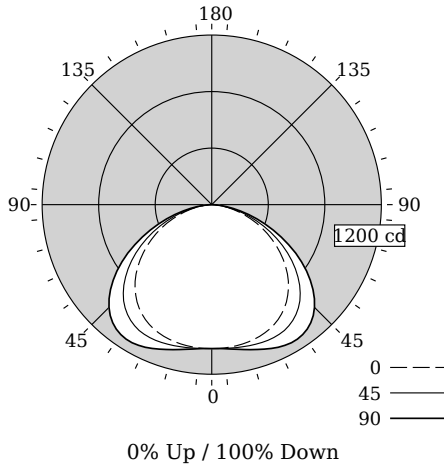

Total Output	3569 lm
Efficacy	98.9 lm/W
CCT	3002K
CRI	81
Distribution	0% Up / 100% Down
Spacing Criteria (0/90°)	1.36/1.63

Fixture photometry has been conducted in accordance with IESNA LM-79-08

IES files for this and other photometric options can be downloaded online at www.lightingproducts.philips.com

Candela Distribution

Vertical Angle	Horizontal Angle				Zonal Lumens
	0	22.5	45	67.5	
0	1018	1018	1018	1018	0
5	1018	1020	1021	1022	98
15	1005	1013	1033	1053	293
25	971	990	1038	1090	480
35	895	924	1000	1084	628
45	767	799	885	982	685
55	590	617	692	775	819
65	393	410	458	515	542
75	198	206	228	255	270
85	45	46	49	54	57
90	0	0	0	0	0
95	0	0	0	0	0
105	0	0	0	0	0
115	0	0	0	0	0
125	0	0	0	0	0
135	0	0	0	0	0
145	0	0	0	0	0
155	0	0	0	0	0
165	0	0	0	0	0
175	0	0	0	0	0
180	0	0	0	0	0

Coefficients of Utilization (%)

RCR	Ceiling Wall	80				70				50				0			
		70	50	30	10	70	50	30	10	50	30	10	0	0	0	0	
0		119	119	119	119	116	116	116	111	111	111	111	111	111	111	100	
1		109	104	99	96	106	101	98	97	94	91	88	85	83	83	83	
2		98	90	83	77	96	88	82	85	79	75	69	65	62	62	62	
3		89	79	70	64	87	77	69	74	67	62	58	54	51	51	51	
4		82	69	60	53	79	68	60	65	58	52	49	45	42	42	42	
5		75	62	52	46	73	61	52	58	51	45	42	38	36	36	36	
6		69	55	46	40	67	54	46	52	45	39	36	32	30	30	30	
7		64	50	41	35	62	49	41	48	40	34	32	28	26	26	26	
8		59	45	37	31	58	45	36	43	36	30	28	24	22	22	22	
9		55	41	33	27	54	41	33	40	32	27	25	21	19	19	19	
10		52	38	30	25	50	38	30	37	29	24	22	18	16	16	16	

Avg. Luminance (cd/m²)

Vertical Angle	Horizontal Angle		
	0	45	90
55	3339	3919	4638
65	3021	3518	4166
75	2482	2865	3386
85	1683	1820	2138

Philips Ledalite

lighting facts®

A Program of the U.S. DOE

Light Output (Lumens) 3568

Watts 36.1

Lumens per Watt (Efficacy) 98

Color Accuracy 81

Color Rendering Index (CRI)

Light Color 3002 (Bright White)

Correlated Color Temperature (CCT)

2700K 3000K 4500K 6500K

Warranty** Yes

All results, except LED Lumen Maintenance, are according to IESNA LM-79-2008: Approved Method for the Electrical and Photometric Testing of Solid-State Lighting. The U.S. Department of Energy (DOE) verifies product test data and results.

** See www.lightingfacts.com/products for details.

Registration Number: F46Z-N24QP7 (7/11/2014)
Model Number: 4x22xxxxL8CD
Type: Luminaire - Troffer/Grid Ceiling

Electrical Specifications

Input Voltage	120V	277V
Input Power	36.1W	35.9W
Input Current	0.31A	0.14A
Power Factor	0.986	0.906
Total Harm. Distortion	14.3%	18.5%
Tested values – contact technical support for rated values. Off-state power zero unless certain controls are specified.		

VERSAFORM 2'X2' LED

DIRECT, BEAM SHAPING LIGHT GUIDE WITH STEPPED DIFFUSER

Options and Details

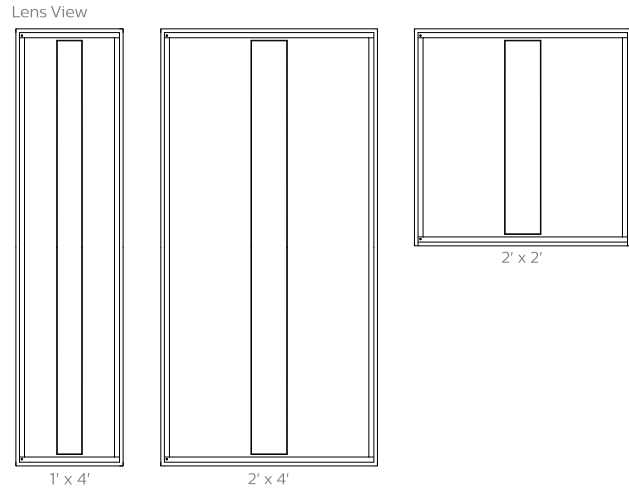
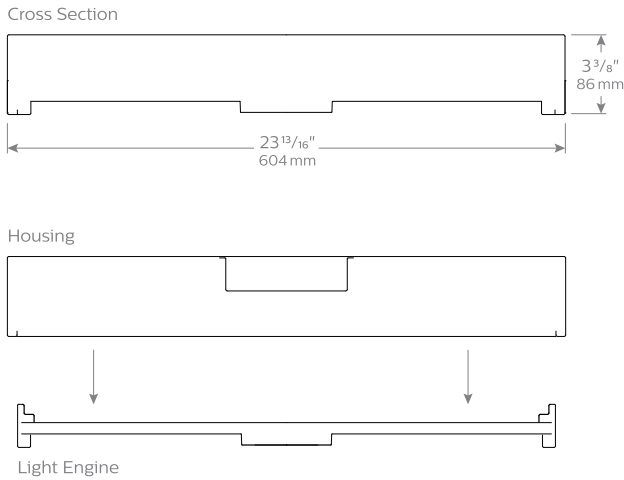

Mounting

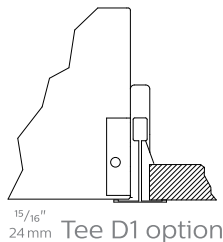

D1 Standard T-Grid

Option D1 works with 9/16" and 15/16" flat T-grid ceilings. It can also be used with slot T-grid ceilings, but it will not sit flush with the bottom of the T-bar.

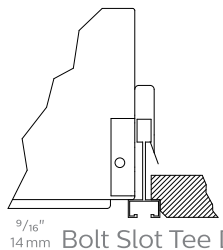

D2 Slot T-Grid

Option D2 is designed to sit close to flush with slot T-grid ceilings and some tegular tile ceiling types.

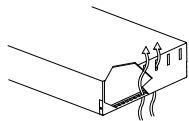

Air Return

Air return is available with the VersaForm 2'x2' & 2'x4' options. Vent area is finished in black.

Housing

Die-formed, post painted, 22 gauge cold-rolled steel. Wire entrance with additional knock-out available on top side for electrical connections.

Weight

Maximum: 2x2 = 24lb, 1x4 = 28lb, 2x4 = 38lb

Optical System

The optical frame assembly consists of integrated LED arrays edgelighting a light guide panel in order to deliver uniform controlled light through a lower lens. The optical frame ends are constructed from die-formed cold-rolled steel, assembled together with extruded aluminum profiles in a sturdy frame. The frame is hinged (side marked) to allow easy access to the inside of the fixture. Maintenance can be performed from below the ceiling.

Standard Driver

0-10V Dimming – 5-100%. Output is class 2 rated, contact factory for other options.

Lumen Maintenance

At an ambient temperature of 25°C, the LED lumen maintenance expectation is $L_{70}(9k) > 54$ kh. Reported according to IES TM-21 Addendum A methodology (9k LM-80 test duration)

Mounting

Recessed: Fixtures can be fastened directly to the T-bar grid and/or tied-off to the building structure. **Surface:** Fixtures can be mounted over recessed junction box and side entry also available.

Electrical

Factory pre-wired with driver safety disconnect.

Wiring

Recessed: Optional flex whips are supplied in 6' lengths. **Surface:** Standard wiring configurations available.

Approvals

Certified to UL, CSA, DLC & IES Standards. City of Chicago Approved CCEA (housing option C).

Finish

Housing and Frame painted, high quality, powder coated matte white only.

Environment

Rated for dry & damp locations in operating in ambient temperatures of 25°C. Certain luminaire components may be adversely affected by contaminants. Damage caused by sulfur, chlorine, petroleum based solutions or other contaminants are not covered under warranty.

Due to continuing product improvements, Philips Ledalite reserves the right to change the specifications without notice.



© 2014 Koninklijke Philips N.V. All rights reserved. Specifications are subject to change without notice. www.philips.com/luminaires

VrsFrm2x2_8-30K40lm 05.17 page 3 of 3

Philips Lighting
North America Corporation
200 Franklin Square Drive
Somerset, NJ 08873
Phone: 855-486-2216

Philips Lighting Company
281 Hillmount Road
Markham ON, Canada L6C
2S3
Phone: 800-668-900