

Unlock your vision

VERSAFORM
1'x4' LED



DIRECT, BEAM SHAPING LIGHT GUIDE WITH STEPPED DIFFUSER
1'x4', 4000 lm 4000K

Project:

Spec Type:

Catalog No: 4114DxxxL8AD

Qty

Line Notes:



Ordering guide

Product Type	Version	Configuration	Light Source *	CRI/CCT	Lumens *	Housing	Wiring †	Voltage	Driver
<input type="text" value="4114"/>	<input type="text"/>	<input type="text" value="ST"/>	<input type="text" value="L"/>	<input type="text"/>	<input type="text" value="D"/>	<input type="text"/>	<input type="text"/>	<input type="text"/>	<input type="text"/>
VersaForm 1'x4' LED	D1 Standard T Grid D2 Slot T Grid S1 Discrete Surface Mount	ST Standalone	L LED	8C CRI 80 3000K 8B CRI 80 3500K 8A CRI 80 4000K 9B CRI 90 3500K	E 3000 lm D 4000 lm	S Standard C Chicago Plenum	1 1 cct 5 1 cct + EM Batt. Pack 7 1 cct Dimming N 1 cct Dimming + EM Batt. Pack T 1 cct Step Dimming	1 120V 2 277V 3 347V	E Philips Advance

* Nominal values within a range. Consult photometry data for exact color temp, lumens & distribution.

† Not all wiring types are available with all configurations. Consult Philips Ledalite for a complete list of available options.

Upgrades & Accessories Please indicate with check mark.

Drywall Kit Trim Mount

Flex Whip

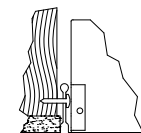

Drywall Kit
Trim mount detail

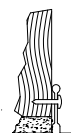

Wood Frame
Can be mounted to wood frame or with hanger wire



Hanger Wire

Integrated Controls Please indicate with check mark.

Response Daylight Sensor Single Zone (DS)

Philips Actilume Occupancy Sensor (DO) (includes field commissionable daylight sensor)



VERSAFORM 1'X4' LED

DIRECT, BEAM SHAPING LIGHT GUIDE WITH STEPPED DIFFUSER

Photometry

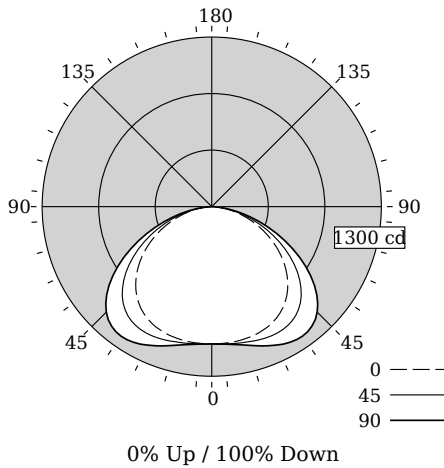

Total Output	3896 lm
Efficacy	111.0 lm/W
CCT	3876K
CRI	83
Distribution	0% Up / 100% Down
Spacing Criteria (0/90°)	1.39/1.70

Fixture photometry has been conducted in accordance with IESNA LM-79-08

IES files for this and other photometric options can be downloaded online at www.lightingproducts.philips.com

Candela Distribution

Vertical Angle	Horizontal Angle				Zonal Lumens
	0	22.5	45	67.5	
0	1053	1053	1053	1053	0
5	1051	1050	1057	1059	101
15	1043	1050	1073	1094	304
25	1017	1033	1091	1148	594
35	949	978	1071	1171	672
45	824	860	970	1090	750
55	646	678	772	877	694
65	437	457	517	585	517
75	229	237	263	294	283
85	60	58	61	61	71
90	0	0	0	0	0
95	0	0	0	0	0
105	0	0	0	0	0
115	0	0	0	0	0
125	0	0	0	0	0
135	0	0	0	0	0
145	0	0	0	0	0
155	0	0	0	0	0
165	0	0	0	0	0
175	0	0	0	0	0
180	0	0	0	0	0

Coefficients of Utilization (%)

RCR	Ceiling Wall	80				70				50				0			
		70	50	30	10	70	50	30	10	50	30	10	0	0	0	0	
0		119	119	119	119	116	116	116	111	111	111	111	111	111	111	100	
1		108	103	99	95	106	101	97	97	97	94	91	83	83	83	83	
2		98	90	83	77	95	88	81	84	79	74	68	68	68	68	68	
3		89	78	70	63	87	77	69	73	67	61	57	57	57	57	57	
4		81	69	60	53	79	67	59	65	57	52	48	48	48	48	48	
5		74	61	52	45	72	60	51	58	50	44	41	41	41	41	41	
6		68	55	45	39	66	54	45	52	44	38	35	35	35	35	35	
7		63	49	40	34	61	48	40	47	39	33	31	31	31	31	31	
8		59	45	36	30	57	44	36	43	35	30	27	27	27	27	27	
9		55	41	32	27	53	40	32	39	32	26	24	24	24	24	24	
10		51	38	29	24	50	37	29	36	29	24	22	22	22	22	22	

Avg. Luminance (cd/m2)

Vertical Angle	Horizontal Angle		
	0	45	90
55	3833	4582	5496
65	3521	4163	4987
75	3006	3460	4054
85	2335	2387	2232

Philips Ledalite

lighting facts®

A Program of the U.S. DOE

Light Output (Lumens) **3898**

Watts **35.1**

Lumens per Watt (Efficacy) **111**

Color Accuracy **83**

Color Rendering Index (CRI)

Light Color **3876 (Bright White)**

Correlated Color Temperature (CCT)

2700K 3000K 4500K 6500K

Warranty** **Yes**

All results, except LED Lumen Maintenance, are according to IESNA LM-79-2008: Approved Method for the Electrical and Photometric Testing of Solid-State Lighting. The U.S. Department of Energy (DOE) verifies product test data and results.

** See www.lightingfacts.com/products for details.

Registration Number: F46Z-SX4VNR (7/11/2014)
Model Number: 4x14xxxxL8AD
Type: Luminaire - Troffer/Grid Ceiling

Electrical Specifications

Input Voltage	120V	277V
Input Power	35.1W	35.0W
Input Current	0.30A	0.14A
Power Factor	0.986	0.897
Total Harm. Distortion	14.7%	18.5%
Tested values – contact technical support for rated values. Off-state power zero unless certain controls are specified.		

VERSAFORM 1'X4' LED

DIRECT, BEAM SHAPING LIGHT GUIDE WITH STEPPED DIFFUSER

Options and Details

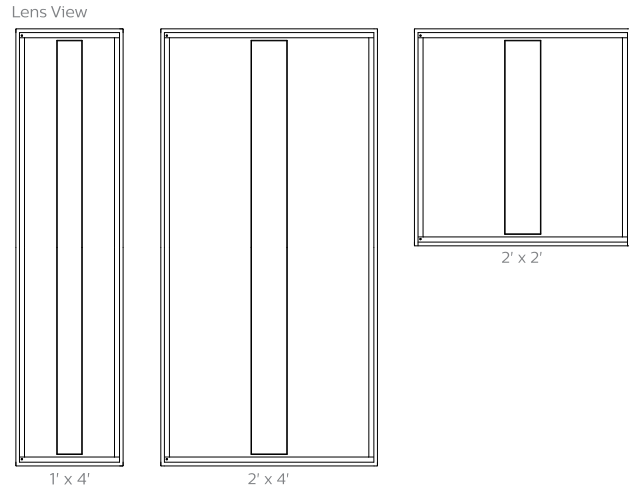
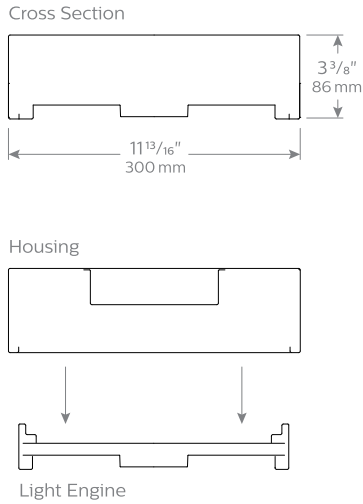

Mounting

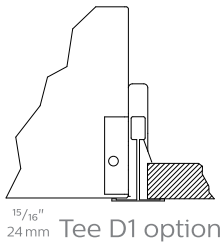

D1 Standard T-Grid

Option D1 works with 9/16" and 15/16" flat T-grid ceilings. It can also be used with slot T-grid ceilings, but it will not sit flush with the bottom of the T-bar.

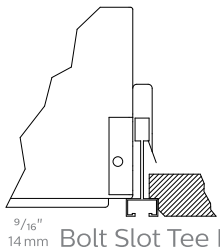

D2 Slot T-Grid

Option D2 is designed to sit close to flush with slot T-grid ceilings and some tegular tile ceiling types.

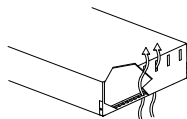

Air Return

Air return is available with the VersaForm 2'x2' & 2'x4' options. Vent area is finished in black.

Housing

Die-formed, post painted, 22 gauge cold-rolled steel. Wire entrance with additional knock-out available on top side for electrical connections.

Weight

Maximum: 2x2 = 24lb, 1x4 = 28lb, 2x4 = 38lb

Optical System

The optical frame assembly consists of integrated LED arrays edgelighting a light guide panel in order to deliver uniform controlled light through a lower lens. The optical frame ends are constructed from die-formed cold-rolled steel, assembled together with extruded aluminum profiles in a sturdy frame. The frame is hinged (side marked) to allow easy access to the inside of the fixture. Maintenance can be performed from below the ceiling.

Standard Driver

0-10V Dimming – 5-100%. Output is class 2 rated, contact factory for other options.

Lumen Maintenance

At an ambient temperature of 25°C, the LED lumen maintenance expectation is L₇₀ (9k) > 54 kh. Reported according to IES TM-21 Addendum A methodology (9k LM-80 test duration)

Mounting

Recessed: Fixtures can be fastened directly to the T-bar grid and/or tied-off to the building structure.
Surface: Fixtures can be mounted over recessed junction box and side entry also available.

Electrical

Factory pre-wired with driver safety disconnect.

Wiring

Recessed: Optional flex whips are supplied in 6' lengths.
Surface: Standard wiring configurations available.

Approvals

Certified to UL, CSA, DLC & IES Standards. City of Chicago Approved CCEA (housing option C).

Finish

Housing and Frame painted, high quality, powder coated matte white only.

Environment

Rated for dry & damp locations in operating in ambient temperatures of 25°C. Certain luminaire components may be adversely affected by contaminants. Damage caused by sulfur, chlorine, petroleum based solutions or other contaminants are not covered under warranty.

Due to continuing product improvements, Philips Ledalite reserves the right to change the specifications without notice.



© 2014 Koninklijke Philips N.V. All rights reserved. Specifications are subject to change without notice. www.philips.com/luminaires

VrsFrm1x4_8-40K40lm 05.17 page 3 of 3

Philips Lighting
North America Corporation
200 Franklin Square Drive
Somerset, NJ 08873
Phone: 855-486-2216

Philips Lighting Company
281 Hillmount Road
Markham ON, Canada L6C
2S3
Phone: 800-668-900