

Voice™



Project Name

Spec Type

Notes

Surface

Direct/Indirect

3 T5

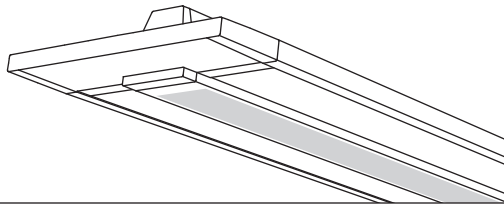

Order Guide

Some combinations of product options may not be available. Consult factory for assistance with your specification.

7316	F03			-		-		-			
Product Series & Type Voice Surface Direct/ Indirect	Lamping 3 T5	Lower Optics I Slot Perf	Upper Optics N 60% Up / 40% Down G 20% Up / 80% Down J 100% Down	Run Length <i>Enter the total run length in feet (4ft increments)</i>	Wiring 1 1 cct 2 2 cct 3 1 cct w/ Emergency cct 4 2 cct w/ Emergency cct 5 1 cct w/ Battery Pack 6 2 cct w/ Battery Pack 7 1 cct Dimming	Voltage 1 120V 2 277V 3 347V	Ballast E Standard Ballast Consult website for ballast manufacturer information	Color & Finish W Standard White	Mounting Hardware <input type="text"/> SF Non-Accessible Ceiling (default if left blank) S61 T-Bar, on Grid (15/16") S62 T-Bar, on Grid (9/16") S63 T-Bar, on Grid (9/16" Slot)		
				See details on reverse	Consult website for complete list of standard wiring options					See details on reverse	

Upgrades & Accessories

Please indicate with check mark.

<input type="checkbox"/> Lamps Included	<input type="checkbox"/> Lamps Included and Installed
<input type="checkbox"/> Flat Endcap See details on reverse	<input type="checkbox"/> Dust Cover Available with upper optics option N (options G & J include integral dust cover)



Response Daylight (Integrated Controls)
For details visit www.ledalite.com/response

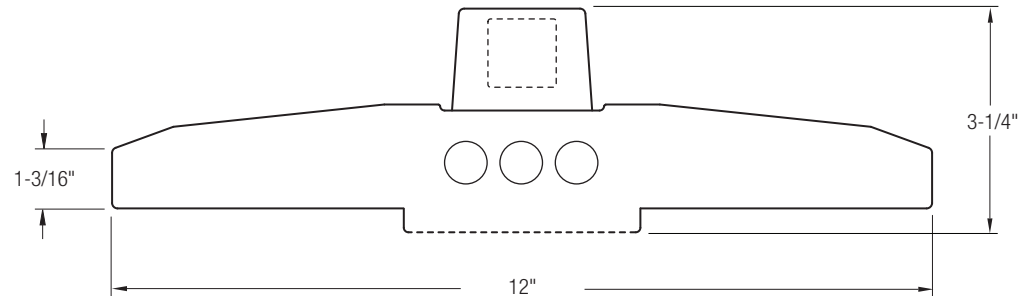

Voice™

Surface
Direct/Indirect
3 T5

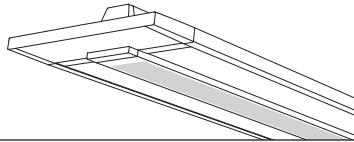

Photometry Optics IJ 100% Down

Report Summary

Efficiency 66%
Peak Candela Value* N/A
Peak to Zenith Ratio* N/A : 1

Report # 9900808
Filename 7306F03IJ.ies
* Between 90-180° vertical angle

Candela Distribution

Vertical Angle	Horizontal Angle					Zonal Lumens
	0	22.5	45	67.5	90	
0	2230	2230	2230	2230	2230	216
5	2221	2225	2230	2235	2239	630
15	2165	2183	2227	2272	2300	996
25	2040	2082	2169	2253	2279	1172
35	1812	1848	1890	1942	1932	1050
45	1420	1406	1349	1337	1299	788
55	982	931	850	828	806	514
65	611	556	478	487	484	245
75	274	235	207	224	212	53
85	35	42	40	49	44	9
90	0	0	0	0	0	12
95	7	7	9	11	10	15
105	8	11	11	12	12	14
115	9	13	15	16	16	12
125	8	12	17	20	19	9
135	8	11	15	20	20	6
145	8	10	14	18	19	3
155	8	9	12	17	18	0
165	7	8	8	10	10	
175	7	7	7	7	7	
180	7	7	7	7	7	

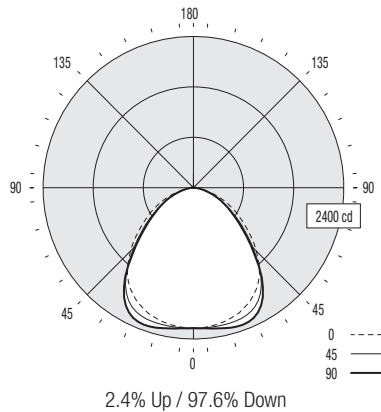

Coefficients of Utilization (%)

Ceiling: Walk:	80				70				50				0			
	70	50	30	10	70	50	30	10	50	30	10	0	50	30	10	0
0 RCR	78	78	78	78	76	76	76	72	72	72	65	65	65	65	65	65
1	72	69	67	65	70	68	65	65	63	61	56	56	56	56	56	56
2	66	61	57	54	64	60	56	57	54	52	48	48	48	48	48	48
3	61	54	49	45	59	53	49	51	47	44	41	41	41	41	41	41
4	56	48	43	39	54	48	43	46	41	38	35	35	35	35	35	35
5	52	44	38	34	50	43	38	41	37	33	31	31	31	31	31	31
6	48	39	34	30	46	39	33	37	33	29	27	27	27	27	27	27
7	44	36	30	26	43	35	30	34	29	26	24	24	24	24	24	24
8	41	33	27	24	40	32	27	31	27	23	22	22	22	22	22	22
9	39	30	25	21	38	30	25	29	24	21	20	20	20	20	20	20
10	36	28	23	19	35	27	23	27	22	19	18	18	18	18	18	18

Based on a floor reflectance of 0.2

Avg. Luminance (cd/m²)

Vertical Angle	Horizontal Angle		
	0	45	90
55	5175	4479	4247
65	4370	3419	3461
75	3200	2417	2476
85	1214	1387	1526

IES files for this and other photometric options can be downloaded online at www.ledalite.com

Additional Information

Modules

Module length excludes endcaps.
Nominal mount spacing for individually mounted modules.

Module	Mount Spacing
4ft	4' 0"
8ft	8' 0"

Endcap

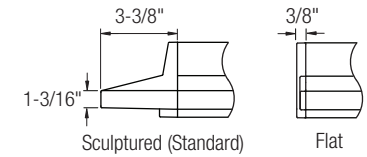

Mounting Hardware

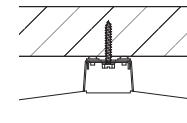

Non-Accessible Ceilings (Standard)

Mounting hardware supplied by others

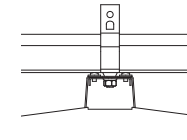

T-Bar (Requires Optional Mount Kit)

Caddy clip supplied by Ledalite

Power Feed Locations

Multiple power feed locations available at fixture ends.

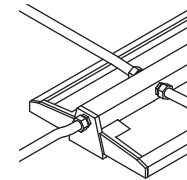

Wiring options for non-accessible ceilings shown. Additional top knockout can be used with T-Bar ceilings.

Specifications

Due to continuing product improvements, Ledalite reserves the right to change specifications without notice.

Housing

18 gauge die-formed cold-rolled steel, precision formed and welded.

Weight

Maximum 5.5 lb/ft.

Optical System

Optical frame is constructed from 20 gauge die-formed cold-rolled steel. The optical lens assembly consists of flat acrylic panels with a layer of MesoOptics® film that provides high-angle glare control and high efficiency. The panels are secured to a perforated center basket using an acrylic lens. Optical door frame is secured to housing with safety straps. Frame can be removed from housing using a lift-and-shift mechanism. No hardware is visible. Standard distribution is 60% up/ 40% down. Also available in 20% up / 80% down and 100% down distributions.

Endcaps

Available with sculptured die-cast endcaps (standard) or flat die-cast endcaps (optional).

Joints

Self-aligning joining system with hands-free pre-joining wire access.

Mounting

Fixtures can be mounted directly to most common ceiling types, including T-bar grid and non-accessible ceilings. Wire access is available from top, side and ends. Continuous run mounting is limited to 32ft on T-bar grid but unlimited in other ceiling types.

Electrical

Factory pre-wired to section ends with quick-wire connectors.

Ballast

Electronic.

Approvals

Certified to UL and CSA standards.

Finish

High-quality powder coat. Available in Ledalite Standard White only (textured matte finish).