

Voice™



Project Name

Spec Type

Notes

Surface
Direct/Indirect
2 T5

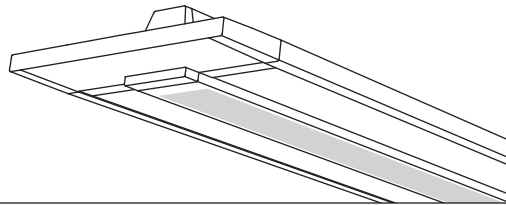

Order Guide

Some combinations of product options may not be available. Consult factory for assistance with your specification.

7316	F02			-		-		-	
Product Series & Type	Lamping	Lower Optics	Upper Optics	Run Length	Wiring	Voltage	Ballast	Color & Finish	
Voice Surface Direct/ Indirect	2 T5	I Slot Perf	N 60% Up / 40% Down G 20% Up / 80% Down J 100% Down	Enter the total run length in feet (4ft increments)	1 1 cct 2 2 cct 3 1 cct w/ Emergency cct 4 2 cct w/ Emergency cct 5 1 cct w/ Battery Pack 6 2 cct w/ Battery Pack 7 1 cct Dimming	1 120V 2 277V 3 347V	E Standard Ballast Consult website for ballast manufacturer information	W Standard White	
						<h3>Mounting Hardware</h3> <p><input type="text"/></p> <p>SF Non-Accessible Ceiling (default if left blank) S61 T-Bar, on Grid (15/16") S62 T-Bar, on Grid (9/16") S63 T-Bar, on Grid (9/16" Slot)</p>			
				See details on reverse	Consult website for complete list of standard wiring options		See details on reverse		

Upgrades & Accessories

Please indicate with check mark.

- | | |
|--|---|
| <input type="checkbox"/> Lamps Included | <input type="checkbox"/> Lamps Included and Installed |
| <input type="checkbox"/> Flat Endcap
See details on reverse | <input type="checkbox"/> Dust Cover
Available with upper optics option N (options G & J include integral dust cover) |
| | |
| <input type="checkbox"/> Response Daylight (Integrated Controls)
For details visit www.ledalite.com/response | |

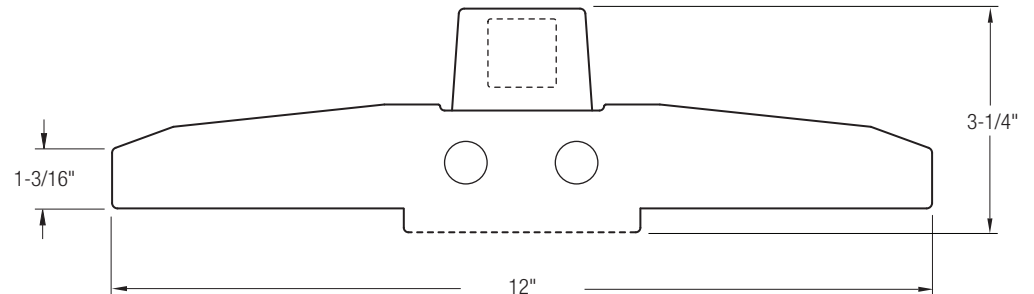

Voice™

Surface
Direct/Indirect
2 T5

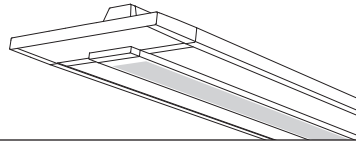

Photometry Optics IJ 100% Down

Report Summary

Efficiency 72.8%
Peak Candela Value* N/A
Peak to Zenith Ratio* N/A : 1

Report # 9900805
Filename 7306F02IJ.ies
* Between 90-180° vertical angle

Candela Distribution

Vertical Angle	Horizontal Angle					Zonal Lumens
	0	22.5	45	67.5	90	
0	1655	1655	1655	1655	1655	
5	1650	1650	1653	1657	1660	161
15	1603	1614	1642	1676	1694	466
25	1507	1531	1594	1662	1687	734
35	1325	1351	1397	1447	1451	866
45	1034	1029	998	997	977	777
55	715	677	623	614	595	579
65	444	404	351	364	357	377
75	193	165	150	163	162	177
85	23	29	28	36	34	39
90	0	0	0	0	0	
95	4	5	6	7	7	7
105	5	7	7	8	8	8
115	6	8	9	10	10	8
125	5	7	11	12	12	8
135	5	7	10	13	14	8
145	6	7	9	11	12	5
155	6	6	7	11	11	4
165	5	6	5	6	6	2
175	5	5	5	5	4	0
180	5	5	5	5	5	

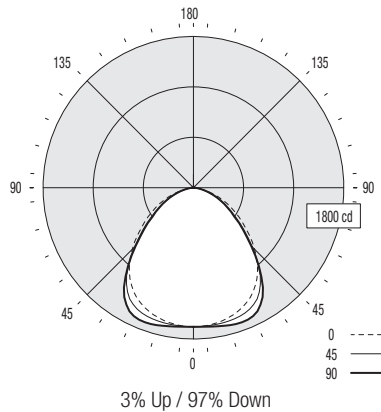

Coefficients of Utilization (%)

Ceiling/Wall:	80				70				50				0
	70	50	30	10	70	50	30	10	50	30	10	0	
0 RCR	86	86	86	86	84	84	84	80	80	80	72		
1	80	77	74	71	78	75	72	72	70	68	62		
2	73	68	63	59	71	66	62	64	60	57	53		
3	67	60	55	50	65	59	54	57	52	49	45		
4	62	54	48	43	60	53	47	51	46	42	39		
5	57	48	42	38	55	47	42	46	41	37	34		
6	53	44	37	33	51	43	37	41	36	32	30		
7	49	40	34	29	48	39	33	38	33	29	27		
8	46	36	30	26	44	36	30	35	30	26	24		
9	43	33	28	24	42	33	27	32	27	23	22		
10	40	31	25	21	39	30	25	30	25	21	20		

Based on a floor reflectance of 0.2

Avg. Luminance (cd/m²)

Vertical Angle	Horizontal Angle		
	0	45	90
55	3768	3283	3135
65	3175	2510	2553
75	2254	1752	1892
85	798	971	1179

IES files for this and other photometric options can be downloaded online at www.ledalite.com

Additional Information

Modules

Module length excludes endcaps.
Nominal mount spacing for individually mounted modules.

Module	Mount Spacing
4ft	4' 0"
8ft	8' 0"

Endcap

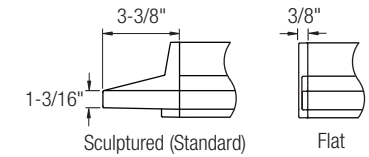

Mounting Hardware

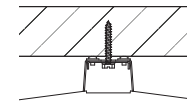

Non-Accessible Ceilings (Standard)

Mounting hardware supplied by others

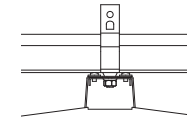

T-Bar (Requires Optional Mount Kit)

Caddy clip supplied by Ledalite

Power Feed Locations

Multiple power feed locations available at fixture ends.

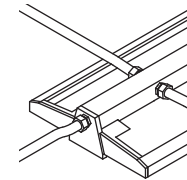

Wiring options for non-accessible ceilings shown. Additional top knockout can be used with T-Bar ceilings.

Specifications

Due to continuing product improvements, Ledalite reserves the right to change specifications without notice.

Housing

18 gauge die-formed cold-rolled steel, precision formed and welded.

Weight

Maximum 5.5 lb/ft.

Optical System

Optical frame is constructed from 20 gauge die-formed cold-rolled steel. The optical lens assembly consists of flat acrylic panels with a layer of MesoOptics® film that provides high-angle glare control and high efficiency. The panels are secured to a perforated center basket using an acrylic lens. Optical door frame is secured to housing with safety straps. Frame can be removed from housing using a lift-and-shift mechanism. No hardware is visible. Standard distribution is 60% up/ 40% down. Also available in 20% up / 80% down and 100% down distributions.

Endcaps

Available with sculptured die-cast endcaps (standard) or flat die-cast endcaps (optional).

Joints

Self-aligning joining system with hands-free pre-joining wire access.

Mounting

Fixtures can be mounted directly to most common ceiling types, including T-bar grid and non-accessible ceilings. Wire access is available from top, side and ends. Continuous run mounting is limited to 32ft on T-bar grid but unlimited in other ceiling types.

Electrical

Factory pre-wired to section ends with quick-wire connectors.

Ballast

Electronic.

Approvals

Certified to UL and CSA standards.

Finish

High-quality powder coat. Available in Ledalite Standard White only (textured matte finish).