

Voice™



Project Name

Spec Type

Notes

Surface
Direct/Indirect
2 T5HO

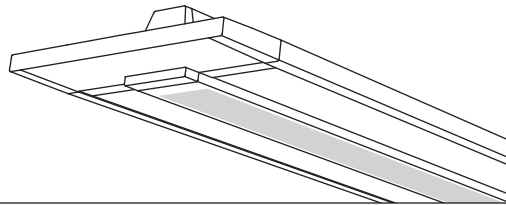

Order Guide

Some combinations of product options may not be available. Consult factory for assistance with your specification.

7316	H02			-		-		-	
Product Series & Type Voice Surface Direct/ Indirect	Lamping 2 T5HO	Lower Optics I Slot Perf	Upper Optics N 60% Up / 40% Down G 20% Up / 80% Down J 100% Down	Run Length <i>Enter the total run length in feet (4ft increments)</i>	Wiring 1 1 cct 2 2 cct 3 1 cct w/ Emergency cct 4 2 cct w/ Emergency cct 5 1 cct w/ Battery Pack 6 2 cct w/ Battery Pack 7 1 cct Dimming	Voltage 1 120V 2 277V 3 347V	Ballast E Standard Ballast Consult website for ballast manufacturer information	Color & Finish W Standard White	
						Mounting Hardware			
						<input type="text"/> SF Non-Accessible Ceiling (default if left blank) S61 T-Bar, on Grid (15/16") S62 T-Bar, on Grid (9/16") S63 T-Bar, on Grid (9/16" Slot)			
					See details on reverse	Consult website for complete list of standard wiring options		See details on reverse	

Upgrades & Accessories

Please indicate with check mark.

<input type="checkbox"/> Lamps Included	<input type="checkbox"/> Lamps Included and Installed
<input type="checkbox"/> Flat Endcap See details on reverse	<input type="checkbox"/> Dust Cover Available with upper optics option N (options G & J include integral dust cover)
<input type="checkbox"/> Response Daylight (Integrated Controls) For details visit www.ledalite.com/response	

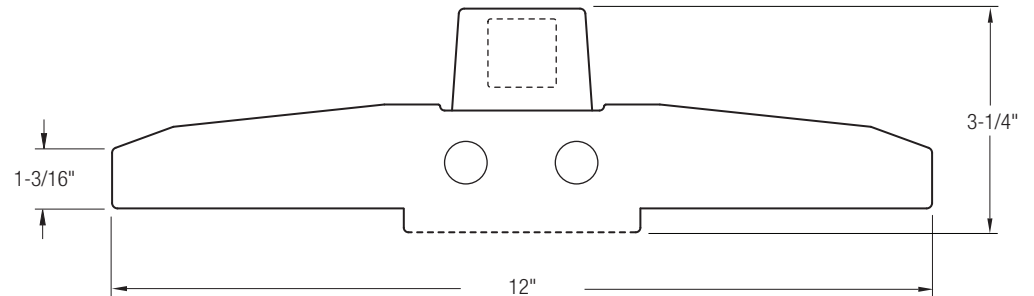

Voice™

Surface
Direct/Indirect
2 T5HO

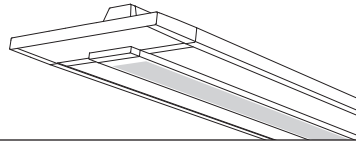

Photometry Optics IG 20% Up / 80% Down

Report Summary

Efficiency 58.8%
Peak Candela Value* 361 @ 180°
Peak to Zenith Ratio* 1 : 1

Report # 9900792
Filename 7306H02IG.ies
* Between 90-180° vertical angle

Candela Distribution

Vertical Angle	Horizontal Angle					Zonal Lumens
	0	22.5	45	67.5	90	
0	1777	1777	1777	1777	1777	171
5	1769	1769	1768	1770	1771	492
15	1716	1721	1736	1757	1768	772
25	1613	1627	1673	1728	1751	926
35	1441	1452	1492	1539	1536	838
45	1149	1127	1074	1064	1032	619
55	808	748	659	632	607	392
65	508	440	356	357	347	176
75	218	180	144	148	141	29
85	29	25	14	15	11	0
90	0	0	0	0	0	51
95	22	33	54	65	72	91
105	86	68	85	97	102	124
115	143	119	119	128	133	153
125	199	188	156	158	163	172
135	248	250	224	198	193	178
145	292	295	294	269	265	152
155	325	326	331	335	336	100
165	348	349	350	351	353	36
175	359	359	360	360	360	
180	361	361	361	361	361	

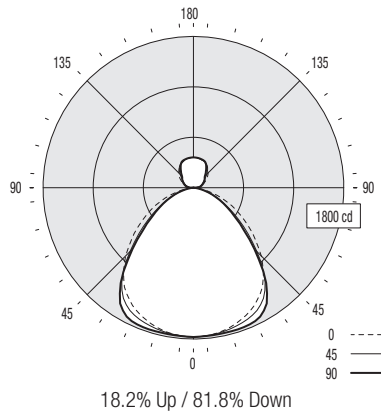

Coefficients of Utilization (%)

Ceiling/Wall:	80				70				50				0			
	70	50	30	10	70	50	30	10	70	50	30	10	70	50	30	10
0 RCR	67	67	67	67	64	64	64	59	59	59	59	59	59	59	47	
1	62	59	57	55	59	57	55	52	51	50	41	41	41	41	41	
2	57	52	49	46	54	50	47	46	44	42	35	35	35	35	35	
3	52	46	42	39	50	45	41	41	38	36	30	30	30	30	30	
4	48	41	37	33	46	40	36	37	33	31	26	26	26	26	26	
5	44	37	32	29	42	36	31	33	30	27	23	23	23	23	23	
6	41	33	29	25	39	32	28	30	26	23	20	20	20	20	20	
7	38	30	26	22	36	29	25	27	24	21	18	18	18	18	18	
8	35	28	23	20	33	27	22	25	21	19	16	16	16	16	16	
9	33	25	21	18	31	24	20	23	19	17	14	14	14	14	14	
10	31	23	19	16	29	23	18	21	18	15	13	13	13	13	13	

Based on a floor reflectance of 0.2

Avg. Luminance (cd/m²)

Vertical Angle	Horizontal Angle		
	0	45	90
55	4258	3473	3199
65	3633	2546	2482
75	2546	1682	1647
85	1006	486	381

IES files for this and other photometric options can be downloaded online at www.ledalite.com

Additional Information

Modules

Module length excludes endcaps.
Nominal mount spacing for individually mounted modules.

Module	Mount Spacing
4ft	4' 0"
8ft	8' 0"

Endcap

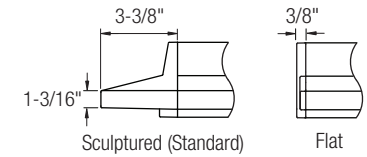

Mounting Hardware

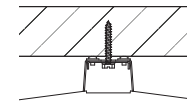

Non-Accessible Ceilings (Standard)

Mounting hardware supplied by others

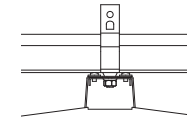

T-Bar (Requires Optional Mount Kit)

Caddy clip supplied by Ledalite

Power Feed Locations

Multiple power feed locations available at fixture ends.

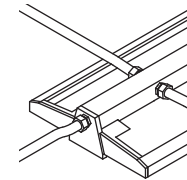

Wiring options for non-accessible ceilings shown. Additional top knockout can be used with T-Bar ceilings.

Specifications

Due to continuing product improvements, Ledalite reserves the right to change specifications without notice.

Housing

18 gauge die-formed cold-rolled steel, precision formed and welded.

Weight

Maximum 5.5 lb/ft.

Optical System

Optical frame is constructed from 20 gauge die-formed cold-rolled steel. The optical lens assembly consists of flat acrylic panels with a layer of MesoOptics® film that provides high-angle glare control and high efficiency. The panels are secured to a perforated center basket using an acrylic lens. Optical door frame is secured to housing with safety straps. Frame can be removed from housing using a lift-and-shift mechanism. No hardware is visible. Standard distribution is 60% up/ 40% down. Also available in 20% up / 80% down and 100% down distributions.

Endcaps

Available with sculptured die-cast endcaps (standard) or flat die-cast endcaps (optional).

Joints

Self-aligning joining system with hands-free pre-joining wire access.

Mounting

Fixtures can be mounted directly to most common ceiling types, including T-bar grid and non-accessible ceilings. Wire access is available from top, side and ends. Continuous run mounting is limited to 32ft on T-bar grid but unlimited in other ceiling types.

Electrical

Factory pre-wired to section ends with quick-wire connectors.

Ballast

Electronic.

Approvals

Certified to UL and CSA standards.

Finish

High-quality powder coat. Available in Ledalite Standard White only (textured matte finish).