

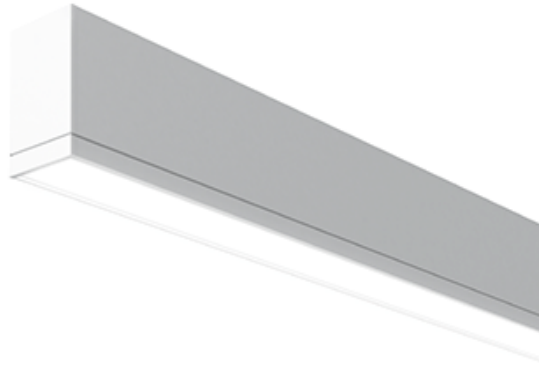

Linear

TruGroove wall

3500 lm/4ft, Direct/Indirect Asym
3000/3500/4000K



Project: _____
 Spec Type: _____
 Catalog No: 2926LxDWW _____
 Qty _____
 Line Notes: _____

TruGroove suspended, surface & wall is driving performance beyond the edge. Innovative optics deliver exceptional uniformity and wide row spacing from a 3” aperture continuous line-of light. An extended family and refined design are perfect for lighting any professional space.

Ordering guide

Product Type	Source	Color Temp *	Lumens *	Lower Optics	Upper Optics	Run Length	Wiring †	Voltage	Driver	Finish
2926	L		D	W	W					
TruGroove wall Direct/Indirect	L LED	A 4000K B 3500K C 3000K	B 5200 lm/4ft (35/65) C 4600 lm/4ft (30/70) D 3500 lm/4ft (35/65)	W Asymmetric MesoOptics	W Asymmetric Performance	04 4' 06 6' 08 8' XX Total run length (2' increments)	7 1 cct Dimming G 2 cct Up/Dn Dimming M 1 cct Dimming + EM Wiring N 1 cct Dimming + EM Batt. Pack	1 120V 2 277V 3 347V	E Philips Advance 0-10V (1% dim)	W Standard White T Titanium Silver B Black C Custom

* Nominal values within a range. Consult photometry data for color temp, lumens & distribution of chosen configuration.
 † Not all wiring types are available with all configurations. Consult Philips Ledalite for a complete list of available options.

Mounting Hardware

Mount Type
 Consult separate mounting spec sheet for mount type options:
Ledalite Suspended Mounting Options

Endcaps - Flat Grooved

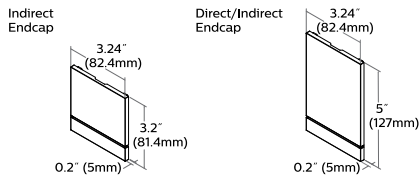

TruGroove wall

3500 lm/4ft, Direct/Indirect Asym

3000/3500/4000K

Optical System

Upper hemisphere: White light emitted from a linear array of upward-facing LEDs is shaped into a homogeneous, wide-throw batwing distribution using either a freeform elliptical lens or an engineered light guide panel.

Lower hemisphere: White light emitted from a linear array of downward-facing LEDs is laterally redirected using either a biconvex lens or optical microstructures embedded in a layer of MesoOptics DX film. An extruded acrylic lens and MesoOptics film assembly then generates an optimal batwing distribution and a uniform continuum of light.

Endcaps

Diecast flat aluminum endcaps with integral groove to match housing.

Finish

High quality powder coated, available in matte white, black or titanium silver. Other custom colors available on request. White sensors only.

Housing

Precision aluminum extrusion, post painted.

Weight

Maximum: Suspended & Surface 3.9lb/ft, Wall 4.1lb/ft & 2'x2' Corner unit 21lb

Electrical

Factory pre-wired to section ends with quick-wire connectors.

QuickShip

Available for certain configurations upon request. More information is available in the links below:

[QuickShip ColorCoded Guide](#)

[QuickShip Order Guide](#)

Standard Drivers

Philips Advance Xitanium 0-10V, 1-100%.
Philips Advance Xitanium SR, 5-100% (for SpaceWise DT).

Class 2 rated output. Consult Philips Ledalite for other available drivers.

Standard Battery Pack

Philips Bodine, 90 min, 10W, Class 2 rated output, Emergency lumen output = 10W x luminaire efficacy x 1.1. Typical output: 1100lm.

Lumen Maintenance

At an ambient temperature of 25°C, the LED lumen maintenance expectation according to IES TM-21-11 is: L80 (12k) 60,000 hrs (**Reported** methodology)
L80 (6k) 110,000 hrs (**Projected** methodology).

Source Color

LEDs rated for color rendering CRI >80, R9 >0 and fixture to fixture color accuracy within 2 SDCM.

Controls

Suspended version available with the following integrated controls:

Response daylight sensor (for single zone).

SpaceWise DT occupancy & daylight sensor w/ advanced grouping & dwell time.

SpaceWise DT commissioning via Android phone and Philips Field App. Compatible dimming wireless wall switches are available. For more information, please refer to www.philips.com/spacewise

Mounting

Suspended: Variable sling mount allows +/- 5" of horizontal adjustment from joint or end. Aircraft cable and tamper-resistant gripper provide unlimited vertical adjustment and are independently tested to stringent safety standards.

Wall: A hidden steel rail and bracket system attaches to the existing structure and supports housings close to the wall. Mount positioning is fully variable along the modules to accommodate site conditions, spaced up to 4½' on center and within 12" of an end or joint.

Surface: Fixture is mounted flush to surface using hidden brackets that attach to existing structure, variable between 0.6"-1.7" from end or joint.

Joints

Self-aligning joining system with hands-free pre-joining wire access.

Approvals

Certified to UL, CSA and IES standards. Certain symmetric indirect/direct and indirect versions are DesignLights Consortium® qualified. Please see the DLC QPL list for exact catalog numbers (www.designlights.org/QPL).

Warranty

Five-year luminaire limited warranty including LED boards and driver.

[USA: Warranty Support](#)

[Canada: Warranty Support](#)

Environment

Rated for dry or damp locations in operating ambient temperatures 0-40°C (32-104°F). Certain luminaire components may be adversely affected by contaminants. Damage caused by sulfur, chlorine, petroleum based solutions or other contaminants in the area of operation are not covered under warranty. Not suitable for natatorium environments.

Due to continuing product improvements, Philips Ledalite reserves the right to change the specifications without notice.

Dimensions - Cross Section

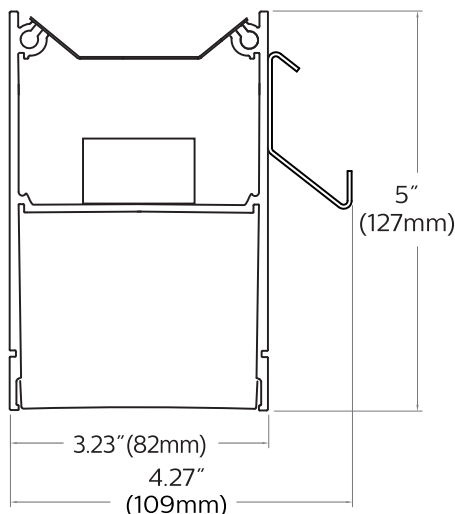

TruGroove wall

3500 lm/4ft, Direct/Indirect Asym

3000/3500/4000K

Dimensions - Modules

Wall Mount Without Endcaps - Top View

12" (305mm)

12" (305mm) -variable mount

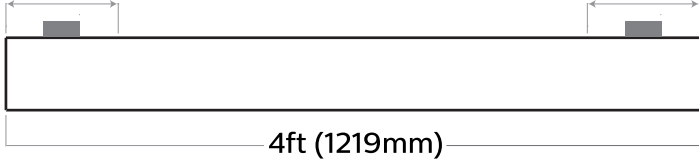

12" (305mm)

12" (305mm)

12" (305mm) -variable mount

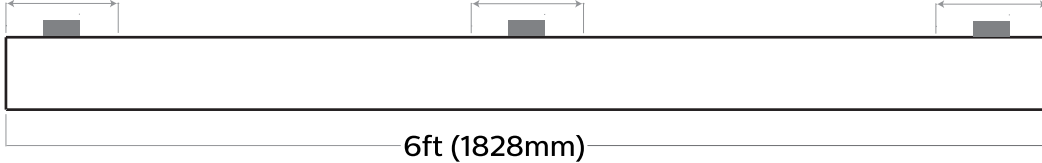

12" (305mm)

12" (305mm)

12" (305mm)
variable
mount

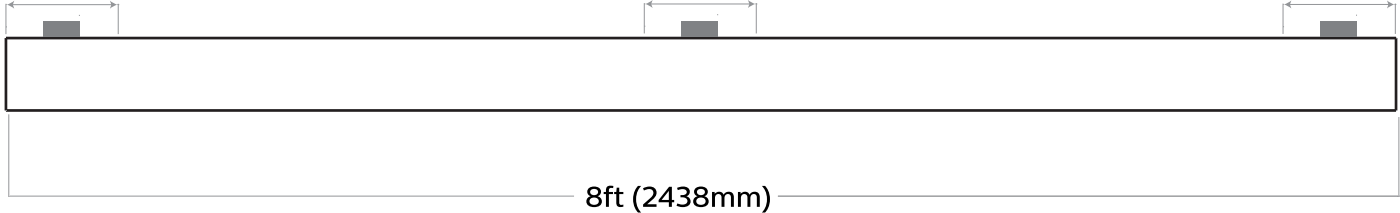

TruGroove wall

3500 lm/4ft, Direct/Indirect Asym

3000/3500/4000K

Photometry - 3500K

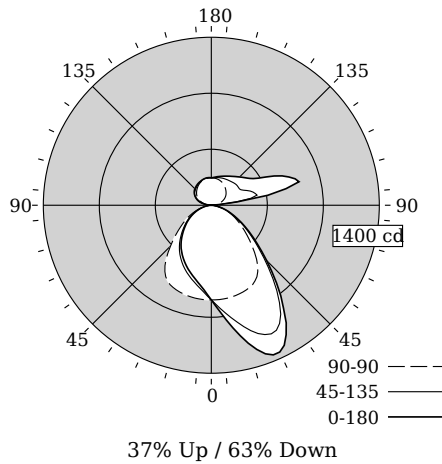

Candela Distribution

Vertical Angle	Horizontal Angle				Zonal Lumens
	0	45	90	135	
0	789	789	789	789	0
5	898	865	789	726	77
15	1191	1048	779	636	238
25	1350	1183	755	554	392
35	1049	990	675	463	445
45	652	619	481	357	378
55	384	366	312	259	281
65	212	207	191	169	188
75	96	93	88	85	95
85	18	16	18	19	22
90	0	0	0	0	0
95	73	64	22	33	69
105	757	379	74	103	245
115	577	296	117	144	229
125	390	271	149	169	196
135	333	264	172	186	172
145	294	253	194	202	141
155	268	246	211	218	106
165	248	238	223	228	66
175	233	230	228	230	22
180	228	228	228	228	0

Values per 4ft unit

Fixture photometry has been conducted in accordance with IESNA LM-79-08

IES files for this and other photometric options can be downloaded online at www.lightingproducts.philips.com

Coefficients of Utilization (%)

RCR	Ceiling										
	70	50	30	10	70	50	30	10	70	50	
0	110	110	110	110	103	103	103	91	91	91	63
1	101	97	93	90	95	91	88	80	78	76	54
2	93	86	80	75	87	81	75	71	67	64	46
3	85	76	69	63	80	71	65	63	58	54	40
4	78	67	60	54	73	64	57	57	51	47	35
5	72	60	52	46	67	57	50	51	45	41	31
6	66	54	46	41	62	52	44	46	40	36	27
7	62	49	41	36	58	47	40	42	36	32	24
8	57	45	37	32	54	43	36	38	33	28	22
9	53	41	34	29	50	39	32	35	30	26	20
10	50	38	31	26	47	36	29	33	27	23	18

Avg. Luminance (cd/m2)

Vertical Angle	Horizontal Angle		
	0	90	180
55	7196	5840	4637
65	5393	4862	4127
75	4002	3670	3471
85	2182	2182	2577

Distribution

Hemisphere	37% Up / 63% Down
Glare Control	Meets RP-1-12 recommendations for VDT-Normal spaces
Spacing Along (0°)	1.66
Spacing Across (90°)	1.34
Spacing at 180°	0.92

TruGroove wall

3500 lm/4ft, Direct/Indirect Asym

3000/3500/4000K

Optical Performance @ 120V

Nominal CCT:	3000K	3500K	4000K
Flux (lm)	3275	3362	3377
Efficacy (lm/W)	94.4	96.6	96.2
Power (W)	34.7	34.8	35.1
CCT (K)	3102	3434	4079
CRI	81	82	83
R9	4	6	13
x	0.4324	0.4118	0.3777
y	0.4072	0.3995	0.3775
Duv	0.0020	0.0020	0.0010

Electrical Performance - 3500K

Input Voltage	120V	277V	347V
Input Power	34.8W	34.9W	31.1W
Input Current	0.29A	0.13A	0.09A
Power Factor	0.997	0.940	0.955
Total Harm. Distortion	8.7%	13.9%	14.0%

Tested values – contact technical support for rated values. Off-state power zero unless certain controls are specified.

