

Transforming light into an element of design

TRUGROOVE STANDALONE PERFORMANCE LED

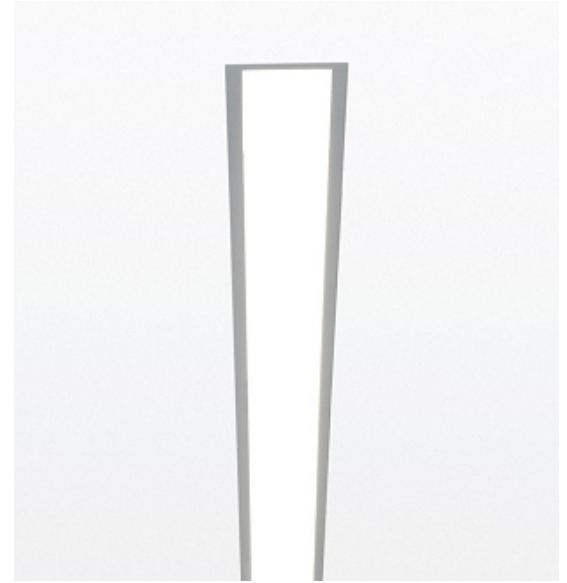

DIRECT PERFORMANCE, FLUSH MESOOPTICS LENS
3000 lm/4ft, Flush Meso
3500K

Project:

Spec Type:

Catalog No: 39S1LBEQ

Qty

Line Notes:



Ordering guide

Product Type	Source	Color Temp *	Lumens *	Optics	Housing	Ceiling / Trim	Run Length	Wiring †	Voltage	Driver
<input type="text" value="39S1"/>	<input type="text" value="L"/>	<input type="text" value="B"/>	<input type="text" value="E"/>	<input type="text" value="Q"/>	<input type="text" value="S"/>	<input type="text"/>	<input type="text"/>	<input type="text"/>	<input type="text"/>	<input type="text"/>
TruGroove Performance LED	L LED	A 4000K B 3500K C 3000K	E 3000 lm/4ft G 2200 lm/4ft K 1500 lm/4ft	Q Flush Meso Lens R Regressed Meso Lens	S Standard C Chicago Plenum	1 T-Grid 3 Drywall Trimless 4 Drywall Trim 5 Armstrong Formations	02 2' 22 2x2' 04 4' 06 6' 08 8' 06 6' 08 8' 10 10' (6' + 4' unit)	7 1 cct Dimming M 1 cct Dimming + EM Wiring N 1 cct Dimming + EM Batt. Pack 1 1 cct 3 1 cct + EM/NL Wiring 5 1 cct + EM Batt. Pack B 2 cct A/B	1 120V 2 277V 3 347V	E Philips Advance 0-10V <i>Other drivers available - consult your Philips representative</i>

* Nominal values within a range. Consult photometry data for exact color temp, lumens & distribution.

† Not all wiring types are available with all configurations. Consult Philips Ledalite for a complete list of available options.

Mounting Hardware

Mount Type

Consult separate mounting spec sheet for mount type options

Integrated Controls Please indicate with check mark.

Response Daylight Single Zone (DS)

SpaceWise DT Occupancy & Daylight Sensor (SZ)



TRUGROOVE STANDALONE PERFORMANCE LED

DIRECT PERFORMANCE, FLUSH MESOOPTICS LENS

Photometry

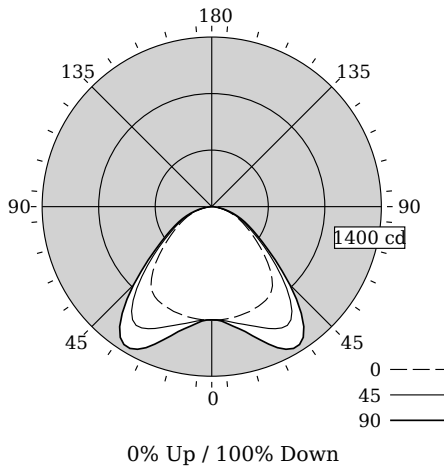

Total Output	3066 lm
Efficacy	74.1 lm/W
CCT	3503K
CRI	83
Distribution	0% Up / 100% Down
Spacing Criteria (0/90/180°)	1.41/1.75/NA

Values per 4ft unit

Fixture photometry has been conducted in accordance with IESNA LM-79-08

IES files for this and other photometric options can be downloaded online at www.lightingproducts.philips.com

Candela Distribution

Vertical Angle	Horizontal Angle				Zonal Lumens
	0	22.5	45	67.5	
0	934	934	934	934	0
5	937	930	943	951	91
15	926	943	1005	1051	285
25	908	969	1110	1239	510
35	856	945	1140	1275	684
45	653	701	816	892	615
55	413	447	475	501	427
65	252	268	278	294	278
75	123	127	135	145	144
85	22	22	26	28	32
90	0	0	0	0	0
95	0	0	0	0	0
105	0	0	0	0	0
115	0	0	0	0	0
125	0	0	0	0	0
135	0	0	0	0	0
145	0	0	0	0	0
155	0	0	0	0	0
165	0	0	0	0	0
175	0	0	0	0	0
180	0	0	0	0	0

Coefficients of Utilization (%)

RCR	Ceiling Wall	80				50				0			
		70	50	30	10	70	50	30	10	50	30	10	0
0		119	119	119	119	116	116	116	111	111	111	100	
1		110	105	102	98	107	103	106	99	96	93	86	
2		101	93	87	81	98	91	85	88	83	78	73	
3		92	82	75	68	90	81	74	78	72	67	62	
4		85	73	65	58	82	72	64	69	63	57	54	
5		78	66	57	51	76	65	56	62	55	50	47	
6		72	59	51	44	70	58	50	56	49	44	41	
7		67	54	45	39	65	53	45	51	44	39	36	
8		62	49	41	35	61	48	40	47	40	35	32	
9		58	45	37	31	57	44	37	43	36	31	29	
10		54	41	33	28	53	41	33	40	33	28	26	

Avg. Luminance (cd/m²)

Vertical Angle	Horizontal Angle		
	0	45	90
55	7910	9106	9801
65	6546	7227	7855
75	5216	5729	6157
85	2793	3301	3555

Lighting facts
A Program of the U.S. DOE

Light Output (Lumens) 3066
Watts 41.4
Lumens per Watt (Efficacy) 74

Color Accuracy
Color Rendering Index (CRI) 83

Light Color
Correlated Color Temperature (CCT) 3503 (Bright White)

Warm White | Bright White | Daylight
2700K | 3000K | 4500K | 6500K

All results are according to IESNA LM-79-08: Approved Method for the Electrical and Photometric Testing of Solid-State Lighting. The U.S. Department of Energy (DOE) verifies product test data and results.

Visit www.lightingfacts.com for the Label Reference Guide.

Registration Number: F46Z-DIVISION (3/12/2014)
Model Number: 39x1LBEQxx04
Type: Luminaire - Linear

Electrical Specifications

Input Voltage	120V	277V
Input Power	41.4W	41.0W
Input Current	0.35A	0.16A
Power Factor	0.988	0.918
Total Harm. Distortion	13.7%	18.5%

Tested values – contact technical support for rated values.
Off-state power zero unless certain controls are specified.

With SpaceWise DT, standby power <0.5W (120V) or <0.8W (277V).

TRUGROOVE STANDALONE PERFORMANCE LED

Modules & Runs

TruGroove Standalone LED nominal housing lengths

2ft, 4ft, 6ft, 8ft

Flush lens trimless versions can be installed in either the wall or ceiling.

Refer to module size details below for actual dimensions e.g. trim. T-grid units fit within a standard 2' grid. To specify continuous runs, refer to TruGroove Continuous data sheets.

Standalone Modules T-Grid & Drywall

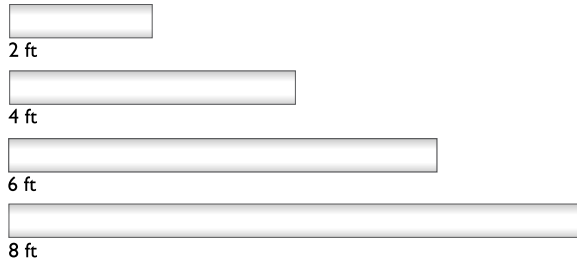

Armstrong® Formations™

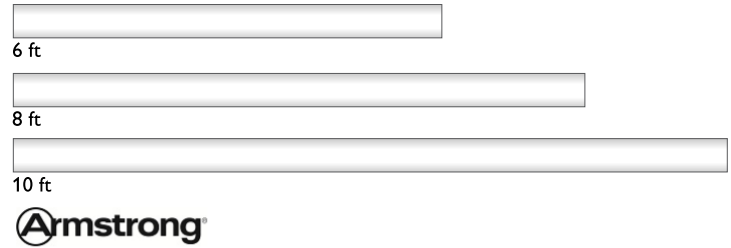

Module Dimensions

Standalone Recessed

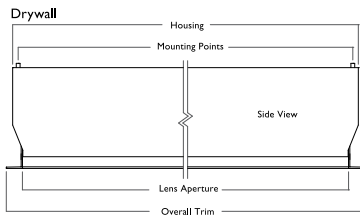
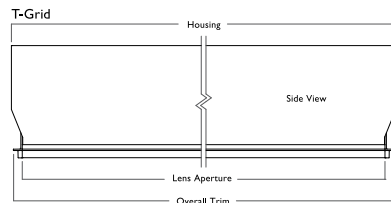

Armstrong Formations

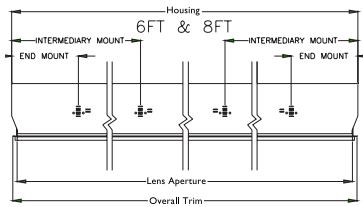

Nominal Lengths	Housing	Lens	Mounting Points	T-Grid	Drywall Trimless	Drywall Trim
2ft	23.9"/607mm	23.0"/584mm	23.4"/584mm	23.75"/603mm	26.35"/669mm	24.5"/622mm
4ft	47.9"/1217mm	47.0"/1194mm	47.4"/1204mm	47.75"/1213mm	50.35"/1279mm	48.5"/1232mm
6ft	71.9"/1826mm	71.0"/1803mm	71.4"/1814mm	71.75"/1822mm	74.35"/1888mm	72.5"/1841mm
8ft	95.9"/2436mm	95.0"/2413mm	95.4"/2423mm	95.75"/2432mm	98.35"/2498mm	96.5"/2451mm

Nominal Lengths	Housing	Lens	Mount Points from End/Join	Intermediary Mount from End/Join	Overall Trim
6ft	71.79"/1823mm	70.88"/1800mm	5.49"/139.5mm	29.49"/749mm	71.63"/1819mm
8ft	95.79"/2433mm	94.88"/2410mm	5.49"/139.5mm	29.49"/749mm	95.63"/2429mm
10ft	119.81"/3043mm	118.84"/3018mm	5.49"/139.5mm	29.49"/749mm	119.58"/3037mm

Options and Details



* Compatible with TechZone® 4" Ceiling Grid and Armstrong Formations

Trim Views

Flush lens



Drywall Trimless



Drywall Trim

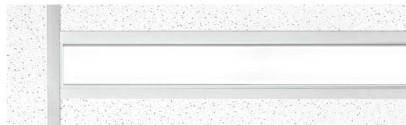

T-grid

Housing

Die-formed 20 gauge cold-rolled steel. Multiple upper wire entrances available for continuous row mounting of fixtures.

Weight

Maximum 3.5lb/ft.

Optical System

Performance version: White light emitted from the LED sources is internally reflected and laterally redirected by a biconvex lens. Light is then reflected by Miro Silver panels and exits through the optical lens assembly. This assembly contains acrylic extrusion profiles to retain a layer of MesoOptics film, creating both an uninterrupted continuum of light and an optical batwing distribution.

Definition version: Light passes through a diffuse white acrylic lens to deliver a highly uniform luminous continuum.

Standard Driver

Dimming: 0-10V, 5-100%. Philips Advance Xitanium Sensor Ready (SR), 5-100% (for SpaceWise). Output is Class 2 rated.

Lumen Maintenance

At an ambient temperature of 25°C in non-insulated contact applications, the LED lumen maintenance expectation for each lumen package is:

K: L₉₀ (12k) 71,000 hrs

G: L₉₀ (12k) 68,000 hrs

E: L₉₀ (12k) 54,000 hrs

Controls

Available with SpaceWise DT occupancy & daylight sensor w/ advanced grouping & dwell time.

* SpaceWise DT commissioning is via a compatible Android phone and Philips Field App. Compatible wireless dimming wall switches are available for dimming. For more information, please refer to www.philips.com/spacewise

Mounting

Mounting brackets on housing sides support T-Grid installation. 1/16" diameter aircraft cable with self-locking, tamper-resistant, miniature cable gripper provides vertical adjustment. Aircraft cable, crimp and gripper independently tested to meet stringent safety requirements.

Compatible with 4" Armstrong TechZone ceiling grid.

Joints

Self-aligning joining system with hands-free pre-joining wire access.

Electrical

Factory pre-wired to section ends with quick-wire connectors.

Approvals

Certified to UL, CSA and IES standards. Insulation Contact (IC) rated.

Finish

Extruded aluminum trim and die-cast endplates coated with electrostatically applied and thermally cured polyester. White sensors only; powder coat paint finish.

Environment

Rated for dry or damp locations in operating ambient temperatures 0-40°C (32-104°F). Certain luminaire components may be adversely affected by contaminants. Damage caused by sulfur, chlorine, petroleum based solutions or other contaminants are not covered under warranty.

Due to continuing product improvements, Philips Ledalite reserves the right to change the specifications without notice.



© 2014 Koninklijke Philips N.V. All rights reserved.
Specifications are subject to change without notice.
www.philips.com/luminaires

TruGrvStndPerfm_35K30lm_Q 08.17 page 4 of 4

Philips Lighting
North America Corporation
200 Franklin Square Drive
Somerset, NJ 08873
Phone: 855-486-2216