

Linear

TruGroove recessed

Regressed MesoOptics Lens
2200 lm/4ft, 3000/3500/4000K



Project: _____
Spec Type: _____
Catalog No: 3901LxGR
Qty: _____
Line Notes: _____

TruGroove recessed delivers unrivaled performance and a truly innovative design – making a definitive statement in any architectural space. TruGroove recessed corners provide endless opportunities for creative freedom with geometric patterns in walls and ceilings.

Ordering guide

Product Type	Source	Color Temp *	Lumens *	Optics	Housing	Ceiling / Trim	Run Length ≈	Wiring †	Voltage	Driver
3901	L		G	R	S					
TruGroove recessed performance	L LED	A 4000K B 3500K C 3000K	D 4000 lm/4ft E 3000 lm/4ft G 2200 lm/4ft K 1500 lm/4ft	Q Flush Meso Lens R Regressed Meso Lens	S Standard C Chicago Plenum	1 T-Grid 3 Drywall Trimless 4 Drywall Trim 5 Armstrong Formations	02 2' 03 3' 04 4' 05 5' 06 6' 08 8' 06 6' 08 8' 10 10' (6' + 4' unit)	7 1 cct Dimming E 2 cct A/B Dimming (Alt. 4ft) M 1 cct Dimming + EM Wiring N 1 cct Dimming + EM Batt. Pack	1 120V 2 277V 3 347V	E Philips Advance 0-10V (1% dim) <i>Other drivers available - consult your Philips representative</i>

* Nominal values within a range. Consult photometry data for CRI, color temp, lumens & distribution of chosen configuration.

† Not all wiring types are available with all configurations. Consult Philips Ledalite for a complete list of available options.

≈ Available in continuous run lengths from 6ft in steps as small as 1/8in for 1500lm/4ft & 2200lm/4ft symmetric configurations.

≈ All 3000lm/4ft, 4000lm/4ft and asymmetric configurations can be specified in 1ft steps.

Ceiling Trims



T-Grid



Drywall Trimless



Drywall Trim

Integrated Controls

Please indicate with check mark.

Response Daylight Single Zone (DS)



TruGroove recessed performance

Regressed MesoOptics Lens

2200 lm/4ft, 3000/3500/4000K

Optical System

Performance version: White light emitted from the LED sources is internally reflected and exits through the optical lens assembly. This assembly contains acrylic extrusion profiles to retain a layer of MesoOptics film, creating both an uninterrupted continuum of light and an optical batwing distribution.

Definition version: Light passes through a diffuse white acrylic lens to deliver a highly uniform luminous continuum.

Finish

Extruded aluminum trim and die-cast endplates coated with electrostatically applied and thermally cured polyester. Powder coat paint finish. White sensors only.

Housing

Die-formed 20 gauge cold-rolled steel. Multiple upper wire entrances available for continuous row mounting of fixtures.

Weight

Maximum 3.5lb/ft.

Electrical

Factory pre-wired to section ends with quick-wire connectors.

Wall Options

Wall mounted luminaires are only available with the Drywall Trimless ceiling / trim option. A continuous ceiling to wall pattern with an inside corner can use a different ceiling / trim option on the ceiling if required. Regressed lens and 4000 lm/4ft configurations are not available for wall mounting.

Standard Drivers

Philips Advance Xitanium 0-10V, 1-100%.
Philips Advance Xitanium Sensor Ready, 5-100%.
Class 2 rated output. Consult Philips Ledalite for other available drivers.

Standard Battery Pack

Philips Bodine, 90 min, 10W, Class 2 rated output,
Emergency lumen output = 10W x luminaire efficacy x 1.1.
Typical output: 1100lm.

Lumen Maintenance

LEDs have been tested by the manufacturer in accordance with IESNA LM-80-08. At an ambient temperature of 25°C in non-insulated contact applications the LED lumen maintenance expectation according to IES TM-21-11 is:
L90 (10k) >60,000 hrs (**Reported** methodology)
L80 (10k) 120,000 hrs (**Calculated** methodology).

Source Color

LEDs rated for color rendering CRI >80, R9 >0 and fixture to fixture color accuracy within 2 SDCM.

Controls

Certain configurations available with:
Response Daylight Sensors
SpaceWise DT Occupancy & Daylight Sensors w/ advanced grouping & Dwell Time.

*SpaceWise DT commissioning is via a compatible Android phone and Philips Field App. Compatible wireless dimming wall switches are available for dimming. 347V is not available as a standard option. For more information, please refer to www.philips.com/spacewise

Mounting

Mounting brackets on housing sides support T-Grid installation. 1/16" diameter aircraft cable with self-locking, tamper-resistant, miniature cable gripper provides vertical adjustment for drywall. Aircraft cable, crimp and gripper independently tested to meet stringent safety requirements.
Compatible with 4" Armstrong TechZone ceiling grid.

Joints

Self-aligning joining system with hands-free pre-joining wire access.

Approvals

Certified to UL, CSA and IES standards. Insulation Contact (IC) rated. Most symmetric, flush lens versions between 1500-3000lm/4ft in 3500K and 4000K are DesignLights Consortium® qualified. Please see the DLC QPL list for exact catalog numbers under DLC family code WWWBXQ (www.designlights.org/QPL).

Warranty

Five-year luminaire limited warranty including LED boards and driver.

USA: <http://www.usa.lighting.philips.com/support/support/warranty>

Canada: <http://www.lighting.philips.ca/support/support/warranty>

Environment

Rated for dry & damp locations in operating in ambient temperatures of 25°C. Many luminaire components, such as reflectors, refractors, lenses, and LEDs are made from various types of plastics which can be adversely affected by airborne contaminants. If sulfur based chemicals, petroleum based products, cleaning solutions, or other contaminants are expected in the intended area of use, consult factory for compatibility. Damage caused by sulfur, chlorine, petroleum based solution or other contaminants are not covered under warranty

Due to continuing product improvements, Philips Ledalite reserves the right to change the specifications without notice.

Corner details and dimensions

Flat 90° Lit Corner Units (Side Views)

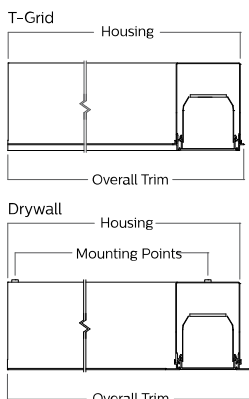

Inside 90° Corner Kit (Side View)

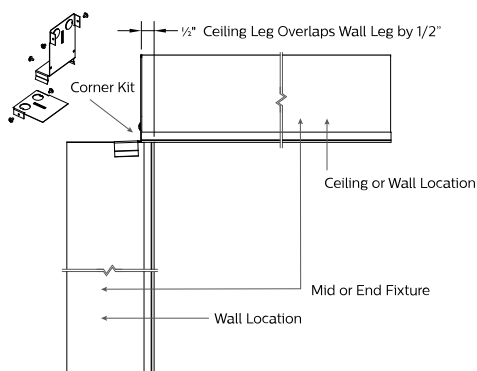

Outside 90° Lit Corner Unit (Top View)

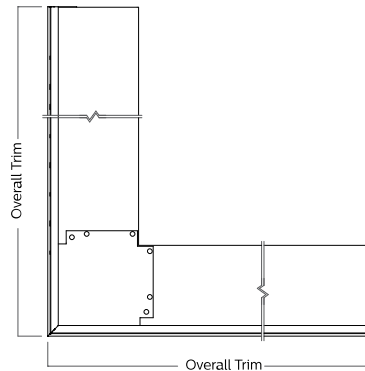

Nominal Length	Housing	Lens	Mounting Points	Trim - T-Grid	Trim - Drywall Trimless	Trim - Drywall Trim
2x2ft Flat	25.7"/653mm	N/A	23.6"/600mm	25.9"/658mm	27.1"/689mm	26.3"/667mm

Nominal Length	Trim-Drywall Trimless
2x2ft Outside	26.8"/681mm

TruGroove recessed performance

Regressed MesoOptics Lens

2200 lm/4ft, 3000/3500/4000K

Ceiling Types

Drywall

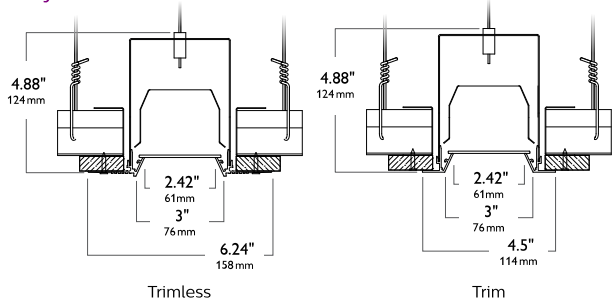

T-grid*

*Compatible with TechZone™ 4" Ceiling Grid

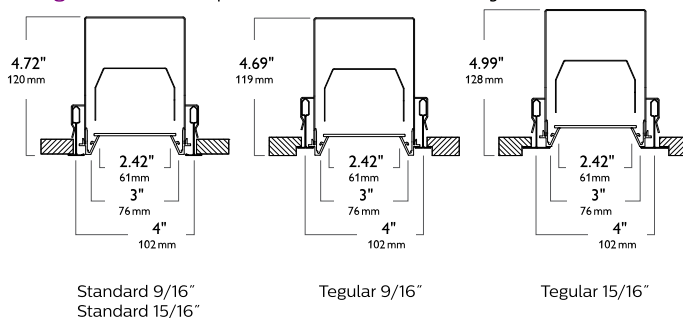

Module Details & Dimensions

Standalone

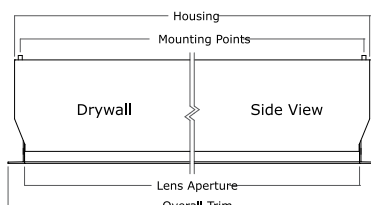
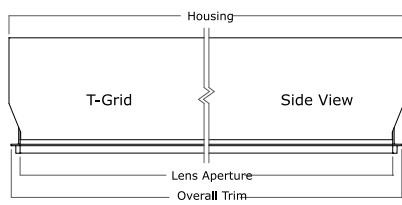

Mid-Run

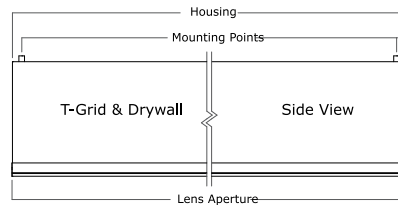

Standalone						
Nominal	Housing	Lens	Mounting Points	Trim - T-Grid	Trim - Drywall Trimless	Trim - Drywall Trim
2ft	23.9"/607mm	23.0"/584mm	23.4"/594mm	23.8"/605mm	26.4"/670mm	24.5"/622mm
3ft	35.9"/912mm	35.0"/889mm	35.4"/899mm	35.8"/909mm	38.4"/975mm	36.5"/927mm
4ft	47.9"/1217mm	47.0"/1194mm	47.4"/1204mm	47.8"/1214mm	50.4"/1280mm	48.5"/1232mm
5ft	59.9"/1521mm	59.0"/1499mm	59.4"/1509mm	59.8"/1519mm	62.4"/1585mm	60.5"/1537mm
6ft	71.9"/1826mm	71.0"/1803mm	71.4"/1814mm	71.8"/1824mm	74.4"/1889mm	72.5"/1841mm
8ft	95.9"/2436mm	95.0"/2413mm	95.4"/2423mm	95.8"/2433mm	98.4"/2499mm	96.5"/2451mm

Mid-Run		
Nominal	Housing & Lens	Mounting Points
2ft	24.0"/610mm	23.2"/589mm
3ft	36.0"/914mm	35.2"/894mm
4ft	48.0"/1219mm	47.2"/1199mm
5ft	60.0"/1524mm	59.2"/1504mm
6ft	72.0"/1829mm	71.2"/1809mm
8ft	96.0"/2438mm	95.2"/2418mm
Incremental	L	L-0.8"

End-Run

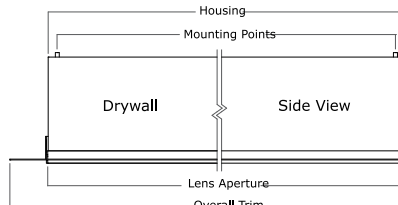
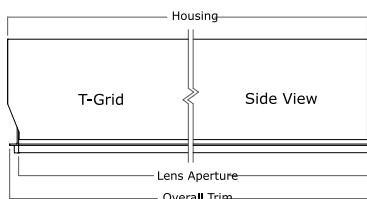

End-Run						
Nominal	Housing	Lens	Mounting Points	Trim - T-Grid	Trim - Drywall Trimless	Trim - Drywall Trim
2ft	24.0"/610mm	23.5"/597mm	23.2"/589mm	23.9"/606mm	25.7"/653mm	24.8"/629mm
3ft	36.0"/914mm	35.5"/901mm	35.2"/894mm	35.9"/910mm	37.7"/957mm	36.7"/933mm
4ft	48.0"/1219mm	47.5"/1206mm	47.2"/1199mm	47.9"/1215mm	49.7"/1262mm	48.7"/1238mm
5ft	60.0"/1524mm	59.5"/1511mm	59.2"/1504mm	59.9"/1520mm	61.7"/1567mm	60.7"/1543mm
6ft	72.0"/1829mm	71.5"/1816mm	71.2"/1809mm	71.9"/1825mm	73.7"/1872mm	72.8"/1848mm
8ft	96.0"/2438mm	95.5"/2425mm	95.2"/2418mm	95.8"/2434mm	97.7"/2481mm	96.7"/2457mm
Incremental	L	L-0.5"	L-0.8"	L-0.1"	L+1.7"	L+0.75"

TruGroove recessed performance

Regressed MesoOptics Lens

2200 lm/4ft, 3000/3500/4000K

Photometry @ CRI>80, 3500K

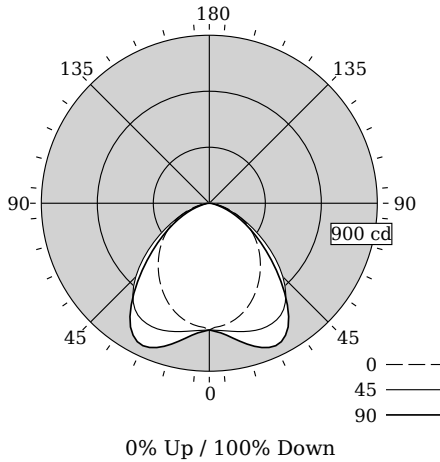

Candela Distribution

Vertical Angle	Horizontal Angle				Zonal Lumens
	0	22.5	45	67.5	
0	679	679	679	679	0
5	662	673	684	695	66
15	625	653	712	765	201
25	557	611	729	819	329
35	472	544	694	747	403
45	380	449	557	533	382
55	286	329	363	321	293
65	186	197	191	164	180
75	86	84	71	56	77
85	17	13	12	12	16
90	0	0	0	0	0
95	0	0	0	0	0
105	0	0	0	0	0
115	0	0	0	0	0
125	0	0	0	0	0
135	0	0	0	0	0
145	0	0	0	0	0
155	0	0	0	0	0
165	0	0	0	0	0
175	0	0	0	0	0
180	0	0	0	0	0

Values per 4ft unit

Fixture photometry has been conducted in accordance with IESNA LM-79-08

IES files for this and other photometric options can be downloaded online at www.lightingproducts.philips.com

Coefficients of Utilization (%)

RCR	Ceiling										
	70	50	30	10	70	50	30	50	30	10	0
0	119	119	119	119	116	116	116	111	111	111	100
1	110	106	102	98	107	103	100	99	96	94	86
2	101	93	87	82	98	91	86	88	83	79	74
3	92	83	75	69	90	81	74	78	72	67	63
4	85	74	65	59	83	72	65	70	63	58	54
5	78	66	58	51	76	65	57	63	56	50	47
6	72	60	51	45	71	59	51	57	50	44	42
7	67	54	46	40	66	53	45	52	45	39	37
8	63	50	41	36	61	49	41	48	40	35	33
9	58	45	37	32	57	45	37	44	37	32	30
10	55	42	34	29	54	41	34	40	34	29	27

Avg. Luminance (cd/m2)

Vertical Angle	Horizontal Angle		
	0	45	90
55	5374	6809	5696
65	4736	4854	3959
75	3594	2935	2139
85	2064	1512	1494

Distribution

Hemisphere	0% Up / 100% Down
Glare Control	Meets RP-1-12 recommendations for VDT-Normal spaces
Spacing Along (0°)	1.14
Spacing Across (90°)	1.54

Philips Ledalite

LED lighting facts
A Program of the U.S. DOE

Light Output (Lumens) **1946**

Watts **20.5**

Lumens per Watt (Efficacy) **94.9**

Color Accuracy **82**

Color Rendering Index (CRI)

Light Color **3500 (Bright White)**

Correlated Color Temperature (CCT)

2700K 3000K 4500K 6500K

All results are according to IESNA LM-79-2008: Approved Method for the Electrical and Photometric Testing of Solid-State Lighting. The U.S. Department of Energy (DOE) verifies product test data and results.

Visit www.lightingfacts.com for the Label Reference Guide.

Registration Number: F46Z-CLMUKA (10/31/2017)
Model Number: 39x1LBGRxx04
Type: Luminaire - Linear

TruGroove recessed performance

Regressed MesoOptics Lens

2200 lm/4ft, 3000/3500/4000K

Optical Performance @ 120V

Nominal Spec:	830	835	840
Flux (lm)	1875	1946	1954
Efficacy (lm/W)	91.5	94.9	95.8
Power (W)	20.5	20.5	20.4
CCT (K)	3040	3437	3948
CRI	84	82	84
R9	16	10	14
x	0.4334	0.4097	0.3836
y	0.4017	0.3945	0.3813
Duv	0.0006	0.0007	0.0013

Electrical Performance @ CRI>80, 3500K

Input Voltage	120V	277V	347V
Input Power	20.5W	20.9W	20.7W
Input Current	0.17A	0.08A	0.06A
Power Factor	0.988	0.924	0.970
Total Harm. Distortion	13.0%	17.6%	11.5%

Tested values – contact technical support for rated values. Off-state power zero unless certain controls are specified.

