



Linear

TruGroove
recessed micro

performance symmetric
2200 lm/4ft, 3000/3500/4000K



Project: _____
Spec Type: _____
Catalog No: 2301LxGQ
Qty: _____
Line Notes: _____

TruGroove recessed micro delivers the perfect combination of slender aesthetic and lighting control, creating luminous environments with exceptional uniformity and wide row spacing from a 1.75" aperture continuous line-of light. An extended family and refined design are perfect for lighting any professional space.

Ordering guide

Product Type	Source	Color Temp *	Lumens *	Optics	Housing	Ceiling / Trim	Run Length ≈	Wiring †	Voltage	Driver
2301	L		G	Q	S					
TruGroove recessed micro symmetric	L LED	A CR180 / 4000K B CR180 / 3500K C CR180 / 3000K S CR190 / 3500K	E 3100 lm/4ft G 2200 lm/4ft K 1500 lm/4ft M1000 lm/4ft	Q Flush Meso Lens	S Standard C Chicago Plenum	1 T-Grid 3 Drywall Trimless 4 Drywall Trim	02 2' 03 3' 04 4' 05 5' 06 6' 08 8' XX Specify Run Length	7 1 cct Dimming M 1 cct Dimming + EM Wiring N 1 cct Dimming + EM Batt. Pack	1 120V 2 277V 3 347V	E Philips Advance 0-10V (1% dim) S Philips Advance SR (5% dim) <i>Other drivers available - consult your Philips representative</i>

* Nominal values within a range. Consult photometry data for CRI, color temp, lumens & distribution of chosen configuration.
† Not all wiring types are available with all configurations. Consult Philips Ledalite for a complete list of available options.
≈ Available in continuous run lengths from 6ft in steps as small as 1/8in for 1000lm/4ft, 1500lm/4ft & 2200lm/4ft symmetric (performance) configurations.
≈ All 3100lm/4ft and asymmetric configurations can be specified in 1ft steps. 2ft standalone modules are not available in asymmetric.

Ceiling Trims



T-Grid



Drywall Trimless



Drywall Trim

Integrated Controls

Please indicate with check mark.

- Response Daylight Single Zone (DS)
- SpaceWise DT Occupancy & Daylight Sensor (SZ)

TruGroove recessed micro symmetric

performance symmetric

2200 lm/4ft, 3000/3500/4000K

Optical System

White light emitted from the LED sources is redirected by a precisely formed reflector and exits through the optical lens assembly. This assembly contains an acrylic extrusion profile retaining a layer of MesoOptic film, creating both an uninterrupted continuum of light and an optical batwing or asymmetric distribution from a 1.75" flush aperture.

Finish

Extruded aluminum trim and die-cast endplates coated with electrostatically applied and thermally cured polyester. Powder coat paint finish. White sensors only.

Housing

Die-formed 20 gauge cold-rolled steel. Multiple upper wire entrances available for continuous row mounting of fixtures.

Weight

Maximum 2.8lb/ft.

Electrical

Factory pre-wired to section ends with quick-wire connectors.

QuickShip

Upon request, TruGroove recessed micro can be made-to-order and shipped in 10-working days from receipt of order.

Some configurations excluded. Limit of 500' linear feet per order.

QuickShip details are available in the links below:

[QuickShip ColorCoded Guide](#)

[QuickShip Order Guide](#)

Standard Drivers

Philips Advance Xitanium 0-10V, 1-100%.
Philips Advance Xitanium SR, 5-100% (SpaceWise DT).
Class 2 rated output. Consult Philips Ledalite for other available drivers.

Standard Battery Pack

Philips Bodine, 90 min, 10W, Class 2 rated output,
Emergency lumen output = 10W x luminaire efficacy x 1.1.
Typical output: 1100lm.

Lumen Maintenance

LEDs have been tested by the manufacturer in accordance with IESNA LM-80-08. At an ambient temperature of 25°C in non-insulation contact applications the LED lumen maintenance expectation according to IES TM-21-11-A is:

CRI>80:

L90 (10k) >60,000 hrs (Reported methodology)

L80 (10k) 128,000 hrs (Calculated methodology).

CRI>90:

L90 (10k) 59,000 hrs (Reported methodology)

L80 (10k) 118,000 hrs (Calculated methodology).

Source Color

LEDs rated for color rendering CRI >80, R9 >0 and fixture to fixture color accuracy within 2 SDCM. Available 90 CRI option is rated for CRI >90, and R9 >60.

Controls

Certain configurations available with:

Response Daylight Sensors

SpaceWise DT Occupancy & Daylight Sensors w/ advanced grouping & Dwell Time.

*SpaceWise DT commissioning is via a compatible Android phone and Philips Field App. Compatible wireless dimming wall switches are available for dimming. For more information, please refer to

www.philips.com/spacewise

Mounting

Mounting brackets on housing sides support T-Grid installation. 1/16" diameter aircraft cable with self-locking, tamper-resistant, miniature cable gripper provides vertical adjustment for drywall. Aircraft cable, crimp and gripper independently tested to meet stringent safety requirements.

Joints

Self-aligning joining system with hands-free pre-joining wire access.

Approvals

Certified to UL, CSA and IES standards. Insulation Contact (IC) rated.

Consult factory for DLC eligible configurations

Warranty

Five-year luminaire limited warranty including LED boards and driver.

[USA: Warranty Support](#)

[Canada: Warranty Support](#)

Environment

Rated for operation in dry and damp locations in ambient temperatures of 25°C. Many luminaire components, such as reflectors, refractors, lenses, and LEDs are made from materials which can be adversely affected by airborne contaminants. If sulfur based chemicals, petroleum based products, cleaning solutions, or other contaminants are expected in the intended area of use, consult factory for compatibility. Damage caused by sulfur, chlorine, petroleum based solution or other contaminants are not covered under warranty

Due to continuing product improvements, Philips Ledalite reserves the right to change the specifications without notice.

Corner details and dimensions

Flat 90° Lit Corner Units (Side Views)

T-Grid

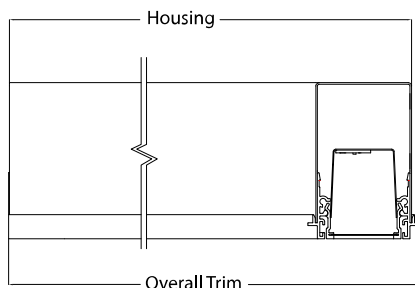

Drywall

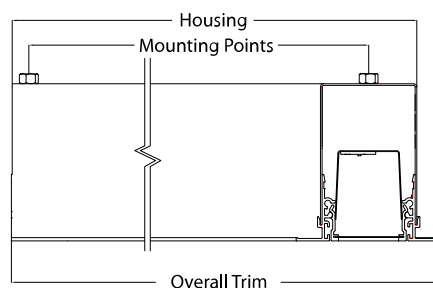

Nominal Length	Housing	Lens	Mounting Points	Trim - T-Grid	Trim - Drywall Trimless	Trim - Drywall Trim
2x2ft Flat	25.1"/637mm	N/A	23.6"/600mm	25.3"/642mm	26.5"/673mm	25.6"/651mm

TruGroove recessed micro symmetric

performance symmetric

2200 lm/4ft, 3000/3500/4000K

Ceiling Types

Drywall

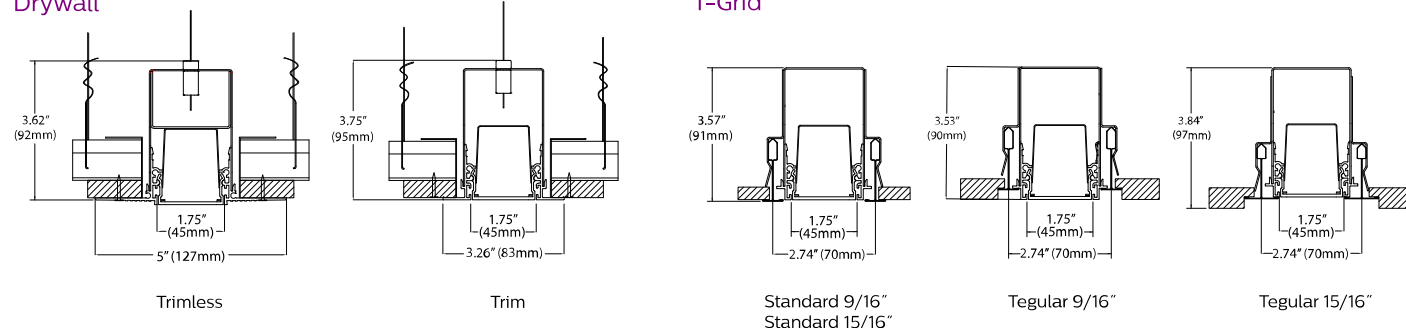

Module Details & Dimensions

Standalone

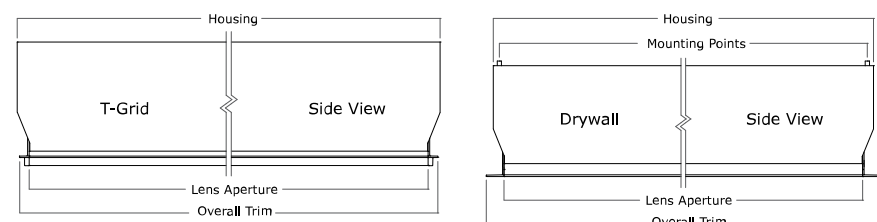

Mid-Run

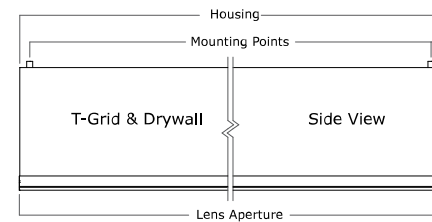

Standalone						
Nominal	Housing	Lens	Mounting Points	Trim - T-Grid	Trim - Drywall Trimless	Trim - Drywall Trim
2ft	23.9"/607mm	23.0"/584mm	23.4"/594mm	23.8"/605mm	26.4"/670mm	24.5"/622mm
3ft	35.9"/912mm	35.0"/889mm	35.4"/899mm	35.8"/909mm	38.4"/975mm	36.5"/927mm
4ft	47.9"/1217mm	47.0"/1194mm	47.4"/1204mm	47.8"/1214mm	50.4"/1280mm	48.5"/1232mm
5ft	59.9"/1521mm	59.0"/1499mm	59.4"/1509mm	59.8"/1519mm	62.4"/1585mm	60.5"/1537mm
6ft	71.9"/1826mm	71.0"/1803mm	71.4"/1814mm	71.8"/1824mm	74.4"/1889mm	72.5"/1841mm
8ft	95.9"/2436mm	95.0"/2413mm	95.4"/2423mm	95.8"/2433mm	98.4"/2499mm	96.5"/2451mm

Mid-Run		
Nominal	Housing & Lens	Mounting Points
2ft	24.0"/610mm	23.2"/589mm
3ft	36.0"/914mm	35.2"/894mm
4ft	48.0"/1219mm	47.2"/1199mm
5ft	60.0"/1524mm	59.2"/1504mm
6ft	72.0"/1829mm	71.2"/1809mm
8ft	96.0"/2438mm	95.2"/2418mm
Incremental	L	L-0.8"/20mm

End-Run

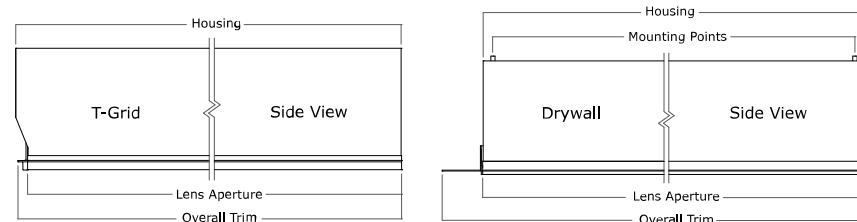

End-Run						
Nominal	Housing	Lens	Mounting Points	Trim - T-Grid	Trim - Drywall Trimless	Trim - Drywall Trim
2ft	24.0"/610mm	23.5"/597mm	23.2"/589mm	23.9"/606mm	25.7"/653mm	24.8"/629mm
3ft	36.0"/914mm	35.5"/901mm	35.2"/894mm	35.9"/910mm	37.7"/957mm	36.7"/933mm
4ft	48.0"/1219mm	47.5"/1206mm	47.2"/1199mm	47.9"/1215mm	49.7"/1262mm	48.7"/1238mm
5ft	60.0"/1524mm	59.5"/1511mm	59.2"/1504mm	59.9"/1520mm	61.7"/1567mm	60.7"/1543mm
6ft	72.0"/1829mm	71.5"/1816mm	71.2"/1809mm	71.9"/1825mm	73.7"/1872mm	72.8"/1848mm
8ft	96.0"/2438mm	95.5"/2425mm	95.2"/2418mm	95.8"/2434mm	97.7"/2481mm	96.7"/2457mm
Incremental	L	L-0.5"/13mm	L-0.8"/20mm	L-0.1"/3mm	L+1.7"/43mm	L+0.75"/19mm

TruGroove recessed micro symmetric

performance symmetric

2200 lm/4ft, 3000/3500/4000K

Photometry @ CRI>80, 3500K

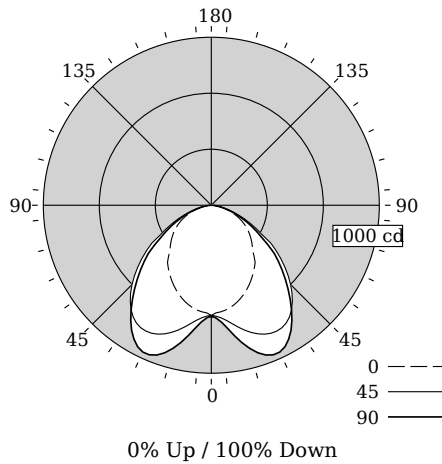

Candela Distribution

Vertical Angle	Horizontal Angle				Zonal Lumens
	0	22.5	45	67.5	
0	656	656	656	656	0
5	637	653	673	693	65
15	596	655	770	859	215
25	527	644	841	947	365
35	448	596	811	849	451
45	345	503	668	645	443
55	269	352	471	441	358
65	183	220	257	239	229
75	90	99	109	102	109
85	19	20	22	22	26
90	0	0	0	0	0
95	0	0	0	0	0
105	0	0	0	0	0
115	0	0	0	0	0
125	0	0	0	0	0
135	0	0	0	0	0
145	0	0	0	0	0
155	0	0	0	0	0
165	0	0	0	0	0
175	0	0	0	0	0
180	0	0	0	0	0

Values per 4ft unit

Fixture photometry has been conducted in accordance with IESNA LM-79-08

IES files for this and other photometric options can be downloaded online at www.lightingproducts.philips.com

Coefficients of Utilization (%)

RCR	Ceiling										
	70	50	30	10	70	50	30	10	70	50	
0	119	119	119	119	116	116	116	111	111	111	100
1	110	105	101	98	107	103	99	99	96	93	85
2	100	92	86	80	98	90	84	87	82	78	72
3	92	81	74	67	89	80	73	77	71	66	61
4	84	72	64	57	82	71	63	69	62	56	53
5	77	65	56	49	75	64	55	61	54	49	46
6	71	58	49	43	69	57	49	56	48	43	40
7	66	53	44	38	64	52	44	50	43	38	35
8	61	48	40	34	60	47	39	46	39	34	31
9	57	44	36	30	56	43	36	42	35	30	28
10	54	41	33	28	52	40	33	39	32	27	25

Avg. Luminance (cd/m2)

Vertical Angle	Horizontal Angle		
	0	45	90
55	8422	14715	12917
65	7786	10926	9724
75	6235	7541	6821
85	3998	4455	4396

Distribution

Hemisphere	0% Up / 100% Down
Glare Control	Meets RP-1-12 recommendations for VDT-Normal spaces
Spacing Along (0°)	1.12
Spacing Across (90°)	1.68

Philips Ledalite

LED lighting facts
A Program of the U.S. DOE

Light Output (Lumens) **2261**

Watts **22.1**

Lumens per Watt (Efficacy) **102.3**

Color Accuracy
Color Rendering Index (CRI) **82**

Light Color
Correlated Color Temperature (CCT) **3500 (Bright White)**

2700K 3000K **Bright White** 4500K Daylight 6500K

All results are according to IESNA LM-79-2008: Approved Method for the Electrical and Photometric Testing of Solid-State Lighting. The U.S. Department of Energy (DOE) verifies product test data and results.

Visit www.lightingfacts.com for the Label Reference Guide.

Registration Number: F46Z-5V6DYX (1/23/2018)
Model Number: 23x1LBGQxx04
Type: Luminaire - Linear

TruGroove recessed micro symmetric

performance symmetric

2200 lm/4ft, 3000/3500/4000K

Optical Performance @ 120V

Nominal Spec:	830	835	840	935
Flux (lm)	2181	2261	2277	2213
Efficacy (lm/W)	98.2	102.3	104.0	86.4
Power (W)	22.2	22.1	21.9	25.6
CCT (K)	3071	3490	4027	3523
CRI	84	82	84	94
R9	16	11	16	71
x	0.4308	0.4061	0.3798	0.4035
y	0.3998	0.3917	0.3782	0.3887
Duv	0.0009	0.0002	0.0009	0.0005

Electrical Performance @ CRI>80, 3500K

Input Voltage	120V	277V	347V
Input Power	22.1W	22.4W	22.2W
Input Current	0.19A	0.09A	0.07A
Power Factor	0.989	0.932	0.933
Total Harm. Distortion	12.1%	17.0%	12.8%

Tested values – contact technical support for rated values. Off-state power zero unless certain controls are specified.

With SpaceWise DT, standby power <0.5W (120V) or <0.8W (277V).

