



# Linear

## TruGroove perimeter graze

3000 lm/4ft  
3000/3500/4000K



Project: \_\_\_\_\_  
Spec Type: \_\_\_\_\_  
Catalog No: 4909LxEP  
Qty: \_\_\_\_\_  
Line Notes: \_\_\_\_\_

Placing emphasis where it belongs... Philips Ledalite brings you the latest high performance lighting solution for your designer toolbox, TruGroove LED perimeter ambient and graze. Whether your desire is to set the mood or create a statement, TruGroove lets you emphasize with illumination.

### Ordering guide

Product Type	Source	Color Temp *	Lumens *	Optics	Housing	Ceiling / Trim	Run Length	Wiring †	Voltage	Driver
4909	L		E	P	S					
TruGroove Perimeter Graze	L LED	A 4000K B 3500K C 3000K	D 4100 lm/4ft E 3000 lm/4ft G 2100 lm/4ft K 1400 lm/4ft	P Reverse Parabolic Optic w/ Flush Lens	S Standard C Chicago Plenum	N All Ceiling Trims  <i>Refer to separate slot &amp; ceiling trim selection.</i>	02 2ft 03 3ft 04 4ft 05 5ft 06 6ft 08 8ft XX Total wall length from 2ft (to 1/8")	7 1cct Dimming	1 120V 2 277V 3 347V	E Philips Advance 0-10V (1% dim)  <i>Other drivers available - consult your Philips representative</i>

\* Nominal values within a range. Consult photometry data for color temp, lumens & distribution of chosen configuration.

† Not all wiring types are available with all configurations. Consult Philips Ledalite for a complete list of available options.

### Endsets (Left/Right) -

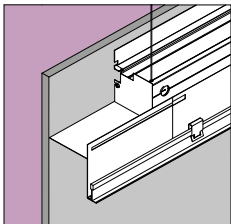

C Variable/Wall endplate

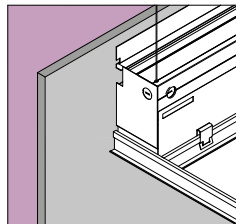

S Fixed/Pocket endplate (S)

### Slot & Ceiling Trim -

Slot Height	Slot Panel	Ceiling Trim
2 1.75"	S Standard Solid	1 T-Grid
4 4"	A Air Return**	3 Drywall Trimless
		4 Drywall Trim

\*\* Air Return is only available with a 4" slot height and T-Grid ceiling trim (e.g. 4A1)



# TruGroove Perimeter Graze

3000 lm/4ft

3000/3500/4000K

## Optical System

**Ambient:** An extruded flush lens assembly with MesoOptics film is used to homogenize and control light from a linear array of downward-facing LEDs. This delivers a uniform, discreet ambient 'glow' along the top of a wall as well as directing fill light into the space.

**Graze:** A highly efficient parabolic reflector mounted in the reverse orientation from the wall focuses light from an angled array of LEDs into a tight linear beam. This creates dramatic grazing shadow effects down the length of a textured wall with textures 1/16" - 1" deep.

## Slot & Trim

Lit modules are regressed into a provided slot, 4" deep as standard or 1.75" deep for narrow plenums. The standard slot avoids direct view of the optics when standing 3' or more from a 9' wall. Slot panels are available to integrate with T-grid or drywall ceilings. The drywall edge can be finished with either a supplied visible extruded aluminum trim or a mud-in 'trimless' flange.

## Ends & Corners

The perimeter slot can be terminated at a chosen position with a flat / pocket end; or at a feature or wall with a variable length / wall end containing a sliding panel to close the plenum. All corners are variable length, with sliding panels and trimmable covers, available in 90° inside or outside versions. Other angles may be handled by request.

## Housing

Precision aluminum extrusion, powder coated in white (Ambient) or black (Graze).

## Weight

Maximum: Ambient 3.6lb/ft, Graze 3.8lb/ft

## Electrical

Factory pre-wired to section ends with quick-wire connectors.

## Standard Driver

Philips Advance Xitanium 0-10V, 1-100%. Class 2 rated output. Consult Philips Ledalite for other available drivers.

## Standard Battery Pack

Philips Bodine, 90 min, 10W, Class 2 rated output, Emergency lumen output = 10W x luminaire efficacy x 1.1. Typical output: 1100lm. Available in ambient version.

## Lumen Maintenance

LEDs have been tested by the manufacturer in accordance with IESNA LM-80-08. At an ambient temperature of 25°C, the LED lumen maintenance expectation according to IES TM-21-11 Reported methodology is: L80 (12k) >72,000 hrs.

## Source Color

LEDs rated for color rendering CRI >80, R9 >0 and fixture to fixture color accuracy within 2 SDCM.

## Mounting

Modules are supported on the wall side by a hidden extruded aluminum rail. On the ceiling side, support and final height adjustment are provided by an aircraft cable and gripper system attached to a bracket on the ceiling structure. Slot panels for closing the plenum are attached using either clips in the case of T-grid ceiling, or a screw mounted finishing trim for drywall.

## Joints

Self-aligning joining system with hands-free pre-joining wire access.

## Approvals

Certified to UL, CSA and IES standards.

## Warranty

Philips indoor professional luminaires 5 year LED warranty: <http://www.philips.com/warranties>

## Environment

Rated for dry or damp locations in operating ambient temperatures 0-40°C (32-104°F). Certain luminaire components may be adversely affected by contaminants. Damage caused by sulfur, chlorine, petroleum based solutions or other contaminants in the area of operation are not covered under warranty. Not suitable for natatorium environments.

Due to continuing product improvements, Philips Ledalite reserves the right to change the specifications without notice.

## Corners (grid shown)

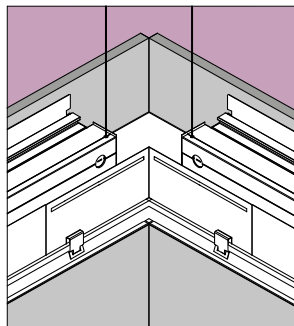

Inside Corner

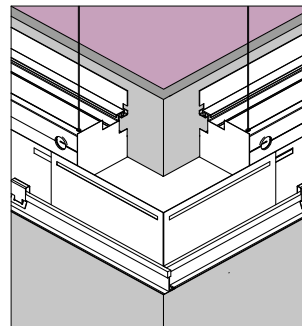

Outside Corner

## Ceiling Trims

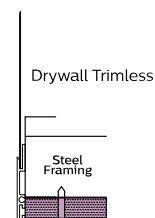
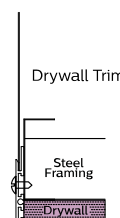
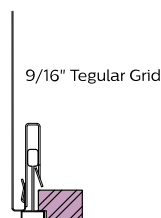
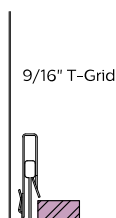
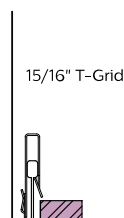

# TruGroove Perimeter Graze

3000 lm/4ft

3000/3500/4000K

## Dimensions

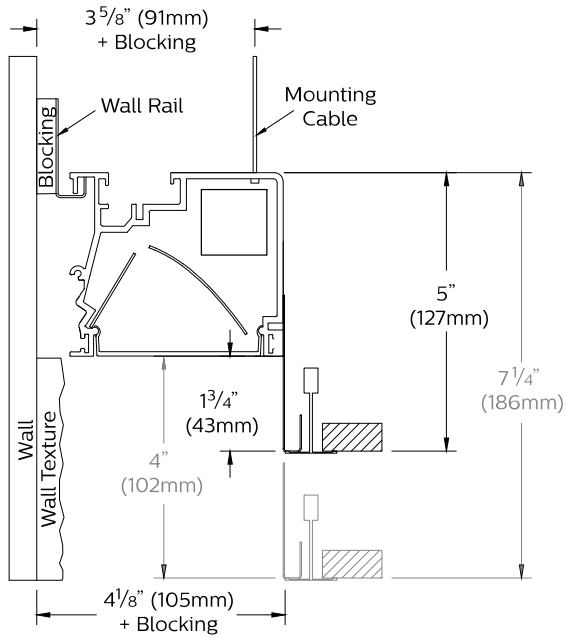

## Modules

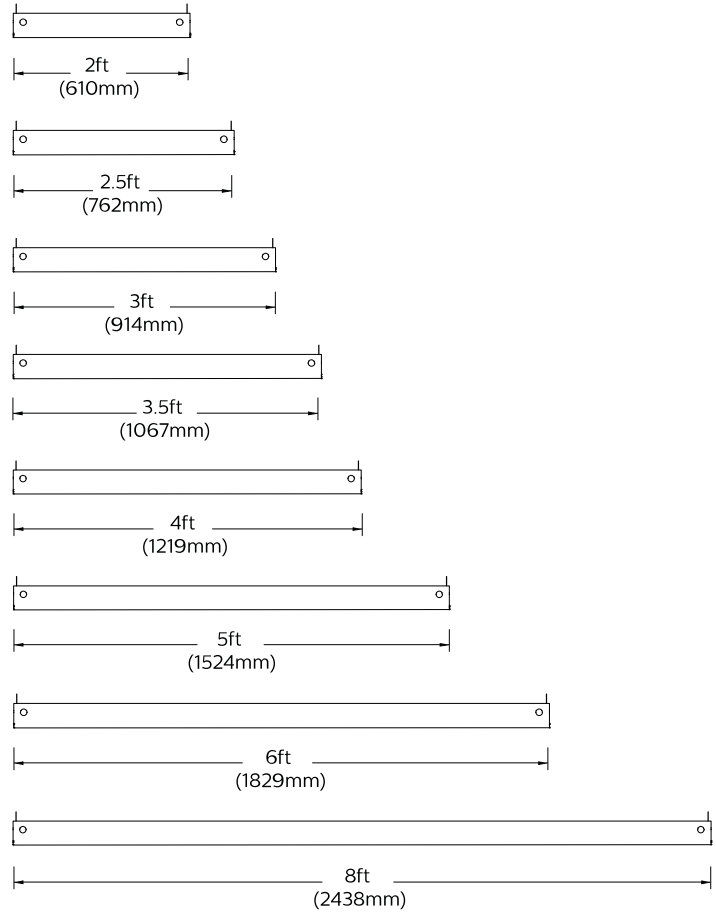

## Side View

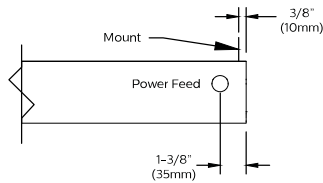

## Top View

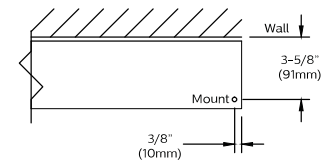

Power feed location available on room side  $1\text{-}\frac{3}{8}$ " (35mm) from each joint or end condition.

# TruGroove Perimeter Graze

3000 lm/4ft  
3000/3500/4000K

## Photometry - 3500K

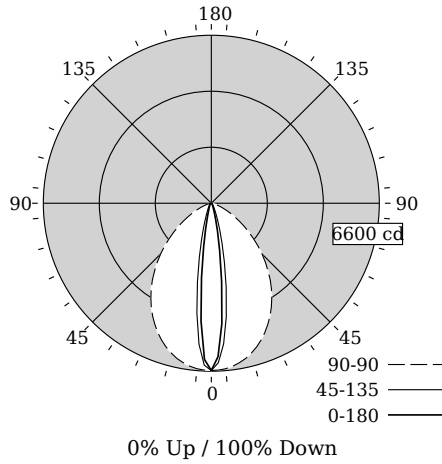

## Candela Distribution

Vertical Angle	Horizontal Angle				Zonal Lumens
	0	22.5	45	67.5	
0	6570	6570	6570	6570	0
5	4752	5547	6525	5556	4643
15	661	1623	6091	1483	639
25	140	381	5251	401	203
35	76	140	4120	185	111
45	40	78	2817	105	62
55	27	49	1577	62	33
65	20	36	648	38	18
75	11	20	183	20	9
85	2	4	22	4	2
90	0	0	0	0	0
95	0	0	0	0	0
105	0	0	0	0	0
115	0	0	0	0	0
125	0	0	0	0	0
135	0	0	0	0	0
145	0	0	0	0	0
155	0	0	0	0	0
165	0	0	0	0	0
175	0	0	0	0	0
180	0	0	0	0	0

Fixture photometry has been conducted in accordance with IESNA LM-79-08

IES files for this and other photometric options can be downloaded online at [www.lightingproducts.philips.com](http://www.lightingproducts.philips.com)

## Coefficients of Utilization (%)

RCR	Ceiling/Wall										
	70	50	30	10	70	50	30	50	30	10	0
0	119	119	119	119	116	116	116	111	111	111	100
1	112	109	106	104	110	107	104	103	101	99	91
2	106	100	95	91	103	98	94	95	91	88	83
3	99	92	86	81	97	90	85	88	83	79	75
4	94	85	79	74	92	84	78	81	76	72	69
5	88	79	72	67	87	78	72	76	71	66	64
6	84	74	67	62	82	73	66	71	66	61	59
7	79	69	62	58	78	68	62	67	61	57	55
8	75	65	58	54	74	64	58	63	58	54	52
9	72	61	55	51	71	61	55	60	54	50	49
10	68	58	52	48	67	58	52	57	51	48	46

## Avg. Luminance (cd/m2)

Vertical Angle	Horizontal Angle		
	0	45	90
55	491	28975	614
65	500	16163	444
75	453	7437	363
85	269	2693	269

## Distribution

Hemisphere	0% Up / 100% Down
Spacing Along (0 °)	0.25
Spacing Across (90 °)	1.09
Spacing at 180 °	0.24

Philips Ledalite

**LED lighting facts**  
A Program of the U.S. DOE

---

**Light Output (Lumens)** **3023**  
**Watts** **27.9**  
**Lumens per Watt (Efficacy)** **108.35**

---

**Color Accuracy**  
Color Rendering Index (CRI) **82**

---

**Light Color**  
Correlated Color Temperature (CCT) **3394 (Bright White)**

2700K    3000K    4500K    6500K

---

All results are according to IESNA LM-79-2008: Approved Method for the Electrical and Photometric Testing of Solid-State Lighting. The U.S. Department of Energy (DOE) verifies product test data and results.

Visit [www.lightingfacts.com](http://www.lightingfacts.com) for the Label Reference Guide.

Registration Number: F46Z-SAHMWA (3/27/2017)  
 Model Number: 49X9LBEP  
 Type: Luminaire - Linear

# TruGroove Perimeter Graze

3000 lm/4ft

3000/3500/4000K

## Optical Performance

Nominal CCT:	3000K	3500K	4000K
Flux (lm)	2884	3023	3047
Efficacy (lm/W)	104.9	108.4	110.0
Power (W)	27.5	27.9	27.7
CCT (K)	3120	3394	4083
CRI	85	82	84
R9	15	4	10
x	0.4279	0.4108	0.3773
y	0.3995	0.3922	0.3763
Duv	0.0006	0.0006	0.0008

## Electrical Performance - 3500K

Input Voltage	120V	277V	347V
Input Power	27.9W	28.0W	27.9W
Input Current	0.24A	0.10A	0.08A
Power Factor	0.950	0.994	0.951
Total Harm. Distortion	14.7%	8.2%	12.0%

Tested values . contact technical support for rated values. Off-state power zero unless certain controls are specified.

