

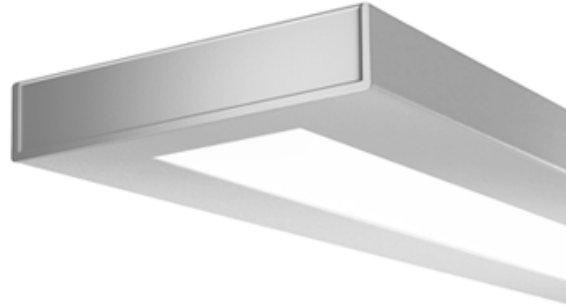

Linear

Sync Suspended

4600 lm/4ft 75% Up
3000/3500/4000K



Project: _____
 Spec Type: _____
 Catalog No: 7406LxCQN _____
 Qty _____
 Line Notes: _____

With its slim, uncluttered design, Sync is the epitome of compact style. Sync offers true direct/indirect lighting distribution and luminous aesthetics with exceptional glare control.

Ordering guide

Product Type	Source	Color Temp *	Lumens *	Lower Optics	Upper Optics	Run Length	Wiring †	Voltage	Driver	Finish
<input type="text" value="7406"/>	<input type="text" value="L"/>	<input type="text"/>	<input type="text" value="C"/>	<input type="text" value="Q"/>	<input type="text" value="N"/>	<input type="text"/>	<input type="text"/>	<input type="text"/>	<input type="text"/>	<input type="text"/>
Sync Direct/Indirect	L LED	A 4000K B 3500K C 3000K	A 6500 lm/4ft C 4600 lm/4ft E 3400 lm/4ft	Q MesoOptics Lens	N Lightguide D 55% Down Kit G 80% Down Kit J 100% Down Kit	04 4' 08 8' XX Total run length (4' increments)	7 1 cct Dimming E 2 cct A/B Dimming M 1 cct Dimming + EM Wiring N 1 cct Dimming + EM Batt. Pack	1 120V 2 277V 3 347V	E Philips Advance 0-10V (1% dim)	W Standard White T Titanium Silver B Black C Custom

* Nominal values within a range. Down kits reduce output & efficacy. Consult photometry data for color temp, lumens & distribution of chosen configuration.
 † Not all wiring types are available with all configurations. Consult Philips Ledalite for a complete list of available options.

Mounting Hardware

Mount Type
Consult separate mounting spec sheet for mount type options

Suspension Length
Distance from ceiling to top of luminaire in inches

Endcaps -

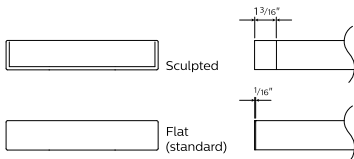

Integrated Controls Please indicate with check mark.

Response Daylight Single Zone (DS)



Sync Suspended

4600 lm/4ft 75% Up

3000/3500/4000K

Optical System

The optical system contains arrays of LEDs edge-lighting a low profile light-guide panel, using total internal reflection to homogenize the sources. The microstructured surface of the panel optimizes light extraction to create an efficacious direct/indirect distribution. Light is purified and controlled by MesoOptics film as it passes through a non-glare acrylic lens. Standard distribution is 75% up / 25% down for suspended and 65% up / 35% down for wall mount version.

Endcaps

Diecast aluminum endcaps, available in flat (standard) or sculpted (optional).

Finish

Standard finish is a textured matte powder coat in white, black or titanium silver.

Housing

Precision formed 18 gauge cold-rolled steel.

Weight

Maximum: Suspended 3.75lb/ft & Wall 3.0lb/ft.

Electrical

Factory pre-wired to section ends with quick-wire connectors.

Standard Driver

Philips Advance Xitanium 0-10V, 1-100%. Class 2 rated output. Consult Philips Ledalite for other available drivers.

Standard Battery Pack

Philips Bodine, 90 min, 10W, Class 2 rated output. Emergency lumen output = 10W x luminaire efficacy x 1.1. Typical output: 1100lm.

Lumen Maintenance

LEDs have been tested by the manufacturer in accordance with IESNA LM-80-08. At an ambient temperature of 25°C, the LED lumen maintenance expectation according to IES TM-21-11 is: L₈₀ (12k) >72,000 hrs (Reported methodology).

Source Color

LEDs rated for color rendering CRI >80 and fixture to fixture color accuracy within 2 SDCM.

Controls

Suspended version available with the following integrated controls:
Response daylight sensor (for single zone).

Mounting

Suspended: Tamper-resistant aircraft cable gripper provides unlimited vertical adjustment. Aircraft cable, crimp and cable gripper are independently tested to meet stringent safety requirements.

Wall: Fixture is mounted flush to wall using hidden wall brackets which attach to existing structure, variable within 2"-5" of end or joint.

Joints

Self-aligning joining system with hands-free pre-joining wire access.

Approvals

Certified to UL, CSA and IES standards. Certain suspended versions without down kits are DesignLights Consortium® qualified. Please see the DLC QPL list for exact catalog numbers (www.designlights.org/QPL).

Warranty

Philips indoor professional luminaires 5 year LED warranty: www.philips.com/warranties.

Environment

Rated for dry or damp locations in operating ambient temperatures 0-40°C (32-104°F). Certain luminaire components may be adversely affected by contaminants. Damage caused by sulfur, chlorine, petroleum based solutions or other contaminants are not covered under warranty. Not suitable for natatorium environments.

Due to continuing product improvements, Philips Ledalite reserves the right to change the specifications without notice.

Dimensions - Cross Section

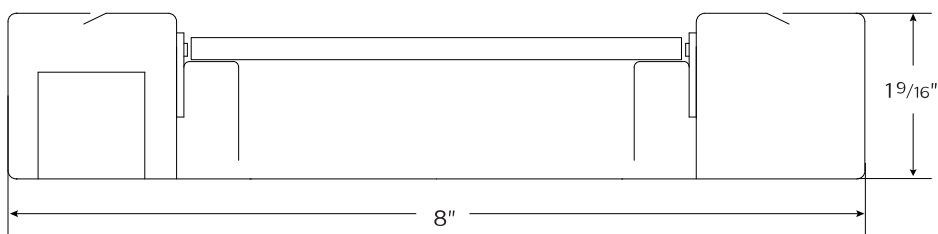

Sync Suspended

4600 lm/4ft 75% Up

3000/3500/4000K

Dimensions - Modules

Modules

Module length excludes end caps. Nominal mounting spacing for individually mounted modules.

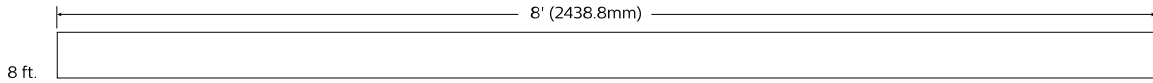
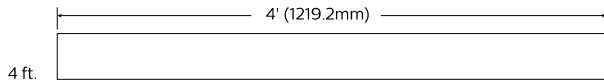

Note: Refer to installation instructions for exact mount.

Optics and Styles

Lens view

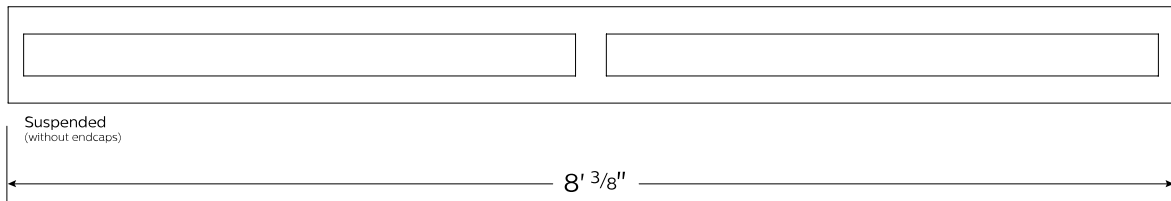

Upper optics



G 80% Down Kit

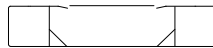

J 100% Down Kit

Sync Suspended

4600 lm/4ft 75% Up
3000/3500/4000K

Photometry - 3500K

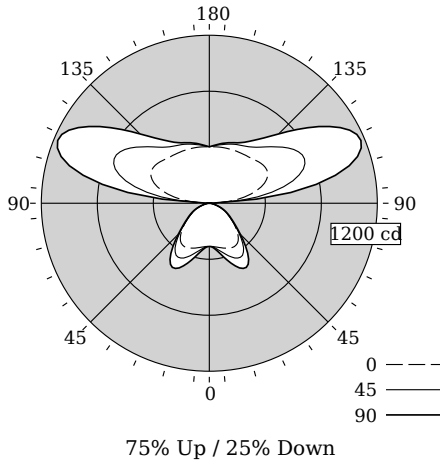

Candela Distribution

Vertical Angle	Horizontal Angle				Zonal Lumens
	0	22.5	45	67.5	
0	309	309	309	309	0
5	310	312	314	318	31
15	329	337	363	389	104
25	352	372	432	487	198
35	349	370	425	472	260
45	278	283	298	309	313
55	185	182	183	189	192
65	109	108	111	115	119
75	45	46	47	49	51
85	8	9	9	9	11
90	0	0	0	0	0
95	134	155	219	305	340
105	349	415	618	897	1035
115	460	536	750	1027	1163
125	472	532	688	870	955
135	445	490	569	661	700
145	426	456	492	532	548
155	417	437	463	475	476
165	410	422	436	444	445
175	405	409	411	414	415
180	403	403	403	403	403

Values per 4ft unit

Fixture photometry has been conducted in accordance with IESNA LM-79-08

IES files for this and other photometric options can be downloaded online at www.lightingproducts.philips.com

Coefficients of Utilization (%)

RCR	Ceiling										70	50	30	10	0
	70	50	30	10	70	50	30	10	0						
0	101	101	101	101	90	90	90	70	70	70	25	0	0	0	0
1	92	88	85	81	82	79	76	61	59	57	22	0	0	0	0
2	84	77	71	67	75	69	64	54	50	48	18	0	0	0	0
3	77	68	61	56	68	61	55	47	43	40	16	0	0	0	0
4	70	60	53	47	62	54	47	42	38	34	13	0	0	0	0
5	64	53	46	40	57	48	41	37	33	29	12	0	0	0	0
6	59	48	40	34	52	43	36	34	29	25	10	0	0	0	0
7	54	43	35	30	48	38	32	30	26	22	9	0	0	0	0
8	50	39	31	26	45	35	28	27	23	19	8	0	0	0	0
9	47	35	28	23	42	32	25	25	20	17	7	0	0	0	0
10	44	32	25	20	39	29	23	23	18	15	6	0	0	0	0

Avg. Luminance (cd/m2)

Vertical Angle	Horizontal Angle		
	0	45	90
55	3126	3104	3241
65	2509	2540	2726
75	1669	1770	1821
85	901	1051	1201

Distribution

Hemisphere	75% Up / 25% Down
Peak/Zenith	2.91
Peak Output	1172 cd
Glare Control	Meets RP-1-12 recommendations for VDT-Critical spaces

Philips Ledalite

LED lighting facts
A Program of the U.S. DOE

Light Output (Lumens) **4608**
Watts **39.4**
Lumens per Watt (Efficacy) **116.95**

Color Accuracy
Color Rendering Index (CRI) **82**

Light Color
Correlated Color Temperature (CCT) **3312 (Bright White)**

2700K 3000K 4500K 6500K

All results are according to IESNA LM-79-2008: Approved Method for the Electrical and Photometric Testing of Solid-State Lighting. The U.S. Department of Energy (DOE) verifies product test data and results.

Visit www.lightingfacts.com for the Label Reference Guide.

Registration Number: F46Z-VP4F2L (10/31/2016)
 Model Number: 7406LBCQN
 Type: Luminaire - Linear

Sync Suspended

4600 lm/4ft 75% Up

3000/3500/4000K

Optical Performance

Nominal CCT:	3000K	3500K	4000K
Flux (lm)	4412	4608	4739
Efficacy (lm/W)	111.7	117.0	120.9
Power (W)	39.5	39.4	39.2
CCT (K)	3045	3312	3931
CRI	84	82	83
R9	10	-1	5
x	0.4338	0.4167	0.3849
y	0.4031	0.3968	0.3837
Duv	0.0000	0.0000	0.0020

Electrical Performance - 3500K

Input Voltage	120V	277V	347V
Input Power	39.4W	38.8W	38.9W
Input Current	0.33A	0.14A	0.12A
Power Factor	0.998	0.980	0.972
Total Harm. Distortion	5.4%	8.8%	9.0%

Tested values . contact technical support for rated values. Off-state power zero unless certain controls are specified.

