

# Sona™

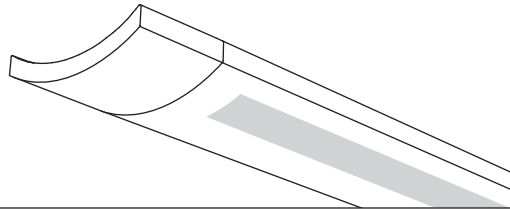

Wall  
Semi-Indirect  
2 T5



Project Name

Spec Type

Notes

## Order Guide

Some combinations of product options may not be available. Consult factory for assistance with your specification.

7708	F02			-		-		-	
Product Series & Type Sona Wall	Lamping 2 T5	Lower Optics L Round Perf Housing I Slot Perf Housing	Upper Optics N None	Run Length <i>Enter the total run length in feet (4ft increments)</i>	Wiring 1 1 cct 2 2 cct 3 1 cct w/ Emergency cct 4 2 cct w/ Emergency cct 5 1 cct w/ Battery Pack 6 2 cct w/ Battery Pack 7 1 cct Dimming	Voltage 1 120V 2 277V 3 347V	Ballast E Standard Ballast	Color & Finish W Standard White C Factory Color X Custom Color	
		See details on reverse		See details on reverse	Consult website for complete list of standard wiring options		Consult website for ballast manufacturer information	Consult website for color and finish options	

## Upgrades & Accessories

Please indicate with check mark.

- |  |   |
|--|---|
| <input type="checkbox"/> Lamps Included                        | <input type="checkbox"/> Lamps Included and Installed |
| <input type="checkbox"/> Flat Endcap<br>See details on reverse | <input type="checkbox"/> Dust Cover                   |

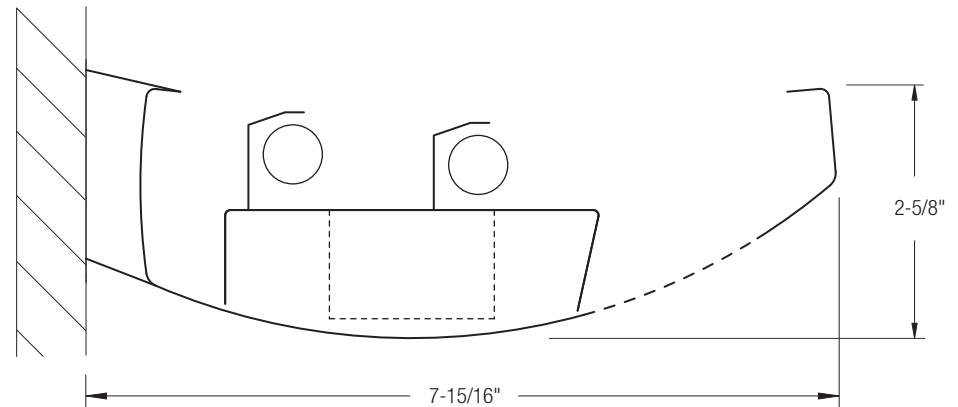

Sona™

Wall  
Semi-Indirect  
2 T5

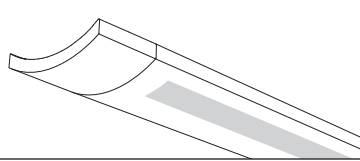

Photometry Optics LN Round Perf Housing

Report Summary

Report # 9900900 Peak Candela Value\* 1628 @ 128°  
 Filename 7708F02LN.ies Peak to Zenith Ratio\* 2 : 1  
 Efficiency 65.6% \* Between 90-180° vertical angle

Meets RP-1-04 recommendations for VDT-Intensive spaces

Candela Distribution

Vertical Angle	Horizontal Angle					Zonal Lumens
	0	22.5	45	67.5	90	
0	14	14	14	14	14	
5	14	14	13	14	14	1
15	17	15	13	15	14	4
25	19	16	13	13	11	6
35	18	16	12	10	9	8
45	15	14	10	8	8	8
55	13	12	9	8	7	8
65	9	9	7	6	5	8
75	5	6	5	5	4	6
85	3	4	4	4	4	4
90	26	22	5	5	8	
95	348	365	63	47	25	102
105	1046	929	180	174	167	423
115	1461	1228	320	217	257	623
125	1627	1290	447	274	273	664
135	1584	1266	564	319	330	621
145	1464	1183	663	426	365	527
155	1261	1093	733	544	482	407
165	1072	987	782	663	616	268
175	884	867	807	771	744	122
180	810	810	810	810	810	

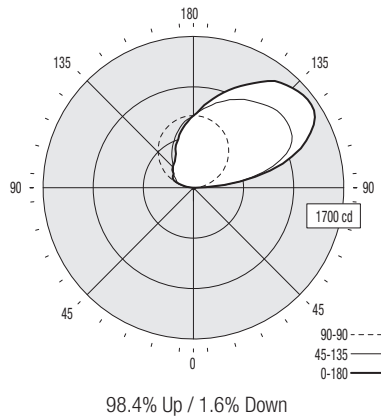

Coefficients of Utilization (%)

Ceiling:	80				70				50				0
	70	50	30	10	70	50	30	10	50	30	10	0	
0 RCR	63	63	63	63	54	54	54	37	37	37	0	0	
1	57	54	52	50	48	46	44	32	31	30	0	0	
2	52	47	43	40	44	40	37	28	26	24	0	0	
3	47	41	37	33	40	35	32	24	22	20	0	0	
4	43	36	32	28	36	31	27	21	19	17	0	0	
5	39	32	27	24	33	28	23	19	16	14	0	0	
6	36	28	24	20	30	24	20	17	14	12	0	0	
7	33	25	21	17	28	22	18	15	12	11	0	0	
8	30	23	18	15	26	20	16	14	11	9	0	0	
9	28	21	16	13	24	18	14	12	10	8	0	0	
10	26	19	14	11	22	16	12	11	9	7	0	0	

Based on a floor reflectance of 0.2

Avg. Luminance (cd/m²)

Vertical Angle	Horizontal Angle		
	0	45	90
55	113	76	61
65	106	80	59
75	96	90	77
85	171	191	229

IES files for this and other photometric options can be downloaded online at [www.ledalite.com](http://www.ledalite.com)

Additional Information

Modules

Module length excludes endcaps.  
Nominal mount spacing for individually mounted modules.

Module	Mount Spacing
4ft	4' 0"
8ft	8' 0"
12ft	12' 0"

\*12ft not available with Direct/Indirect

Endcap

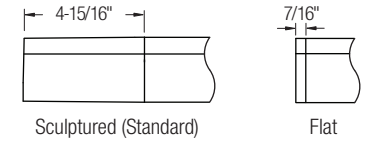

Mounting Hardware

- Mounts variable within 6" of end or joint.
- Minimum one mount per fixture end or joint. **Note:** Mount is not continuous, and therefore fixture is not flush with wall.
- Side-mounted 4" x 2-1/2" utility box (supplied by others).

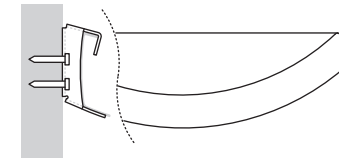

Lower Optics

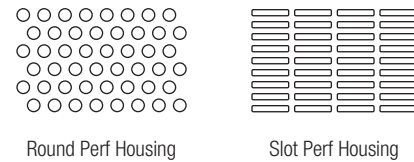

Specifications

Due to continuing product improvements, Ledalite reserves the right to change specifications without notice.

Housing

Die-formed 20 gauge cold-rolled steel.

Weight

3.2 lb/ft.

Optical System

Direct/Indirect: Constructed of 96% reflective white steel and specular aluminum to produce an asymmetric direct/indirect distribution. Semi-specular louvers are aluminum and spaced 1-7/16" apart. White louvers are spaced 1-5/16" apart. Standard distribution is 70% up and 30% down.

Semi-Indirect: Constructed of 96% reflective white steel to produce an asymmetric semi-indirect distribution. Perforated housing available in round or slot perforation patterns.

Endcaps

Available with either die-cast sculptured endcaps (standard) or flat die-cast endcaps (option).

Joints

Self-aligning joining system with hands-free pre-joining wire access.

Mounting

Fixture is mounted 1/2" off the wall by means of individual brackets. The brackets are specifically designed for ease of installation.

Electrical

All luminaires shall be factory pre-wired to section ends with quick-wire connectors.

Ballast

Electronic.

Approvals

Certified to UL & CSA standards.

Finish

High-quality powder coat. Available in Ledalite Standard White (textured matte finish), and a selection of other factory and customer-specified colors. Consult factory for details.