

Sona™

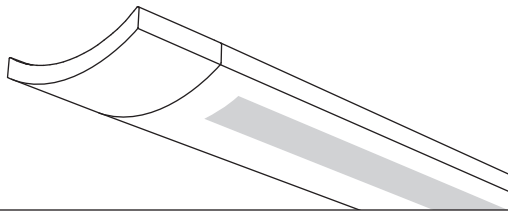

Wall
Semi-Indirect
1 T8



Project Name

Spec Type

Notes

Order Guide

Some combinations of product options may not be available. Consult factory for assistance with your specification.

7708	T01			-		-		-	
Product Series & Type Sona Wall	Lamping 1 T8	Lower Optics L Round Perf Housing I Slot Perf Housing	Upper Optics N None	Run Length <i>Enter the total run length in feet (4ft increments)</i>	Wiring 1 1 cct 3 1 cct w/ Emergency cct 5 1 cct w/ Battery Pack 7 1 cct Dimming	Voltage 1 120V 2 277V 3 347V	Ballast E Standard Ballast	Color & Finish W Standard White C Factory Color X Custom Color	
		See details on reverse		See details on reverse	Consult website for complete list of standard wiring options		Consult website for ballast manufacturer information	Consult website for color and finish options	

Upgrades & Accessories

Please indicate with check mark.

- | | |
|--|---|
| <input type="checkbox"/> Lamps Included | <input type="checkbox"/> Lamps Included and Installed |
| <input type="checkbox"/> Flat Endcap
See details on reverse | <input type="checkbox"/> Dust Cover |

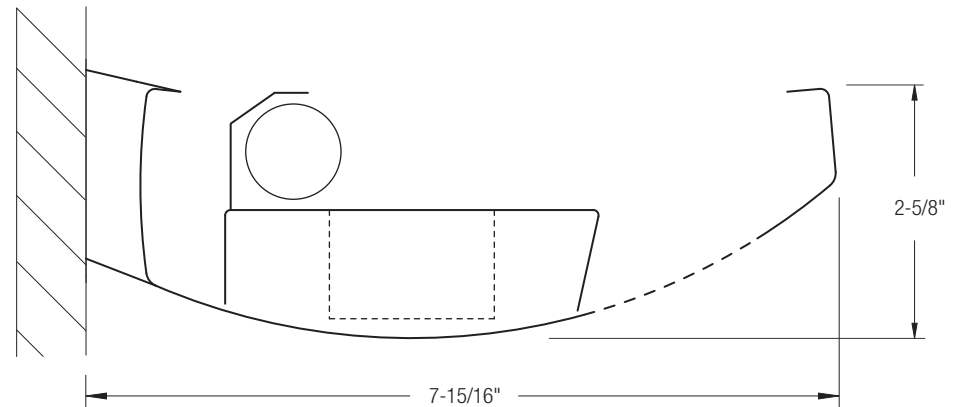

Sona™

Wall
Semi-Indirect
1 TB

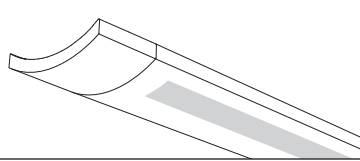

Photometry Optics LN Round Perf Housing

Report Summary

Report # 9900771 **Peak Candela Value*** 798 @ 113°
Filename 7708T01LN.ies **Peak to Zenith Ratio*** 2.2 : 1
Efficiency 62.7% * Between 90-180° vertical angle

Meets RP-1-04 recommendations for VDT-Intensive spaces

Candela Distribution

Vertical Angle	Horizontal Angle				Zonal Lumens
	0	22.5	45	67.5	
0	5	5	5	5	5
5	5	5	5	5	0
15	6	5	5	5	0
25	8	6	5	5	3
35	7	6	4	4	4
45	6	6	4	3	4
55	5	5	3	4	4
65	4	4	3	3	4
75	2	3	2	3	4
85	1	2	2	2	4
90	38	31	1	3	2
95	291	251	30	42	41
105	738	571	80	90	112
115	798	584	140	103	123
125	755	566	196	118	131
135	698	546	248	141	143
145	632	519	289	178	161
155	561	482	322	225	197
165	476	435	344	276	253
175	397	383	355	329	319
180	357	357	357	357	357

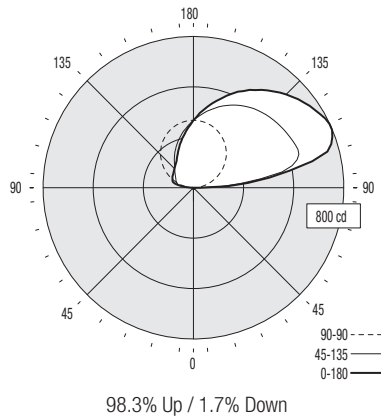

Coefficients of Utilization (%)

Ceiling-Wall	80				70				50				0
	70	50	30	10	70	50	30	10	50	30	10	0	
0 RCR	60	60	60	60	51	51	51	35	35	35	0	0	
1	54	52	49	47	46	44	42	30	29	28	0	0	
2	49	45	41	38	42	38	36	26	25	23	0	0	
3	45	39	35	32	38	34	30	23	21	19	0	0	
4	41	35	30	27	35	30	26	20	18	16	0	0	
5	37	31	26	22	32	26	22	18	16	14	0	0	
6	34	27	22	19	29	23	19	16	14	12	0	0	
7	31	24	20	16	27	21	17	14	12	10	0	0	
8	29	22	17	14	25	19	15	13	10	9	0	0	
9	27	20	15	12	23	17	13	12	9	8	0	0	
10	25	18	14	11	21	15	12	11	8	7	0	0	

Based on a floor reflectance of 0.2

Avg. Luminance (cd/m²)

Vertical Angle	Horizontal Angle		
	0	45	90
55	43	25	26
65	47	34	35
75	38	36	58
85	57	95	114

IES files for this and other photometric options can be downloaded online at www.ledalite.com

Additional Information

Modules

Module length excludes endcaps.
Nominal mount spacing for individually mounted modules.

Module	Mount Spacing
4ft	4' 0"
8ft	8' 0"
12ft	12' 0"

*12ft not available with Direct/Indirect

Endcap

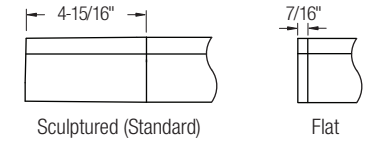

Mounting Hardware

- Mounts variable within 6" of end or joint.
- Minimum one mount per fixture end or joint. **Note:** Mount is not continuous, and therefore fixture is not flush with wall.
- Side-mounted 4" x 2-1/2" utility box (supplied by others).

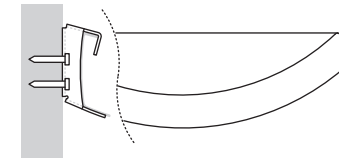

Lower Optics

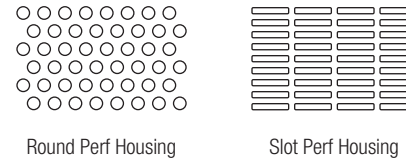

Specifications

Due to continuing product improvements, Ledalite reserves the right to change specifications without notice.

Housing

Die-formed 20 gauge cold-rolled steel.

Weight

3.2 lb/ft.

Optical System

Direct/Indirect: Constructed of 96% reflective white steel and specular aluminum to produce an asymmetric direct/indirect distribution. Semi-specular louvers are aluminum and spaced 1-7/16" apart. White louvers are spaced 1-5/16" apart. Standard distribution is 70% up and 30% down.

Semi-Indirect: Constructed of 96% reflective white steel to produce an asymmetric semi-indirect distribution. Perforated housing available in round or slot perforation patterns.

Endcaps

Available with either die-cast sculptured endcaps (standard) or flat die-cast endcaps (option).

Joints

Self-aligning joining system with hands-free pre-joining wire access.

Mounting

Fixture is mounted 1/2" off the wall by means of individual brackets. The brackets are specifically designed for ease of installation.

Electrical

All luminaires shall be factory pre-wired to section ends with quick-wire connectors.

Ballast

Electronic.

Approvals

Certified to UL & CSA standards.

Finish

High-quality powder coat. Available in Ledalite Standard White (textured matte finish), and a selection of other factory and customer-specified colors. Consult factory for details.