



Recessed

SilkSpace

2'x4', 5200 lm
4000K



Project: _____
 Spec Type: _____
 Catalog No: 4224DxxxL8AC _____
 Qty _____
 Line Notes: _____

Philips Ledalite SilkSpace LED recessed combines LED Light Guide technology and Ledalite's revolutionary MesoOptics technology to deliver discrete, comfortable lighting with great performance and ultra low-glare.

Ordering guide

Product Type	Version	Configuration	Light Source *	CRI/CCT	Lumens *	Housing	Wiring †	Voltage	Driver
4224	D1		L	8A	C				
SilkSpace 2'x4' LED	D1 Standard T Grid	ST Standalone CR Continuous Row	L LED	8C CRI 80 3000K 8B CRI 80 3500K 8A CRI 80 4000K	D 4000 lm C 5200 lm A 6800 lm	S Standard C Chicago Plenum	7 1 cct Dimming N 1 cct Dimming + EM Batt Pack	1 120V 2 277V 3 347V	E Philips Advance 0-10V S Philips Advance SR

* Nominal values within a range. Consult photometry data for exact color temp, lumens & distribution.

† Not all wiring types are available with all configurations. Consult Philips Ledalite for a complete list of available options.

Upgrades & Accessories Please indicate with check mark.

- Drywall Kit Trim Mount
- Flex Whip (6' length)

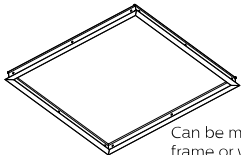

Can be mounted to wood frame or with hanger wire

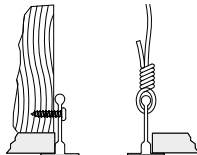

Integrated Controls Please indicate with check mark.

- Response Daylight Sensor Single Zone (DS)
- Philips Actilume Occupancy Sensor (DO) (includes field commissionable daylight sensor)
- SpaceWise DT Occupancy & Daylight Sensor (SZ)



SilkSpace

2'x4', 5200 lm
4000K

Housing

Sides and center spine: precision aluminum extrusion; end caps, back housing and driver cover: die-formed, 20 gauge cold-rolled steel, pre and post painted. Available in white. Multiple wire entrances are available (top or side) to allow continuous row mounting of fixtures.

Electrical

Factory pre-wired with driver safety disconnects. Dimming enabled as standard: 0-10V (1-100%). Philips Advance Xitanium Sensor Ready (SR), 5-100% (for SpaceWise). Output is Class 2 rated. Consult factory for a list of other options. LED boards and drivers are easily field replaceable, if required.

Lumen Maintenance

Lumen maintenance of the LEDs has been tested by the manufacturer in accordance with IESNA LM-80-08. At an ambient temperature of 25°C, the LED lumen maintenance expectation is L80(12K)>72,000h according to IES TM-21-11 Addendum A Reported methodology.

Controls

Available with the following integrated controls:
Response daylight sensor (for single zone).
Philips Actilume occupancy sensor (includes field commissionable daylight).
SpaceWise DT occupancy & daylight sensor w/ advanced grouping & dwell time.
SpaceWise DT commissioning via Android phone and Philips Field App. Compatible dimming wireless wall switches are available. For more information, please refer to www.philips.com/spacewise

Weight

Maximum 28lbs (2x4); 21lbs (1x4); 15lbs (2x2).

Mounting

Fixtures are factory pre-wired and tested for all circuits and emergency battery packs. Compatible with 15/16" lay-in acoustical ceilings using exposed grid suspension (NEMA type G). For 9/16" slot T-grid ceilings, fixture will sit 5/16" above bottom of Tee. Optional armored cable flex whips are supplied in 6' lengths.

Warranty

Five-year luminaire limited warranty including LED boards and driver.

USA: <http://www.usa.lighting.philips.com/support/support/warranty>

Canada: <http://www.lighting.philips.ca/support/support/warranty>

Certifications

SilkSpace luminaires are DesignLights Consortium® qualified. Please see the DLC QPL list for exact catalog numbers (<http://www.designlights.org/QPL>)

Environment

Rated for dry & damp locations in operating in ambient temperatures of 25°C.

General Notes

Many luminaire components, such as reflectors, refractors, lenses, sockets, lamp holders, and LEDs are made from various types of plastics which can be adversely affected by airborne contaminants. If sulfur based chemicals, petroleum based products, cleaning solutions, or other contaminants are expected in the intended area of use, consult factory for compatibility. Damage caused by sulfur, chlorine, petroleum based solution or other contaminants are not covered under warranty.

Optical System

The optical system is comprised of arrays of LEDs edge-lighting a low profile light guide panel. The microstructured surface of the light guide panel optimizes the light extraction creating a homogenously luminous appearance. Light is then controlled by MesoOptics film suppressing the high-angle light creating an ultra low-glare bat-wing distribution.

Approvals

Certified to UL, CSA & IES Standards. City of Chicago Approved CCEA (housing option C).

Due to continuing product improvements, Philips Ledalite reserves the right to change the specifications without notice.

Options and Details

Mounting

Integrates with most common T-Grid ceiling types

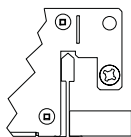

Flat T-Grid

Works with 9/16" & 15/16" flat T-Grid ceilings

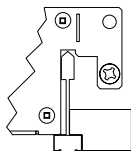

Slot T-Grid

Can also be used with slot T-Grid ceilings. For 9/16" slot T-grid ceilings, fixture will sit 5/16" above bottom of T-Bar.

Cross Section

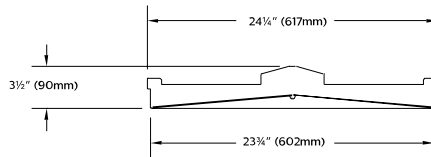

Lens View

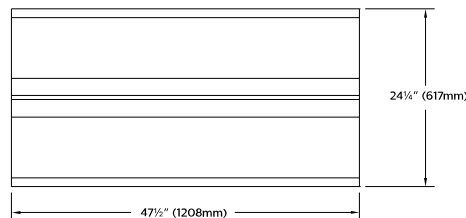

Side View



SilkSpace

2'x4', 5200 lm
4000K

Photometry

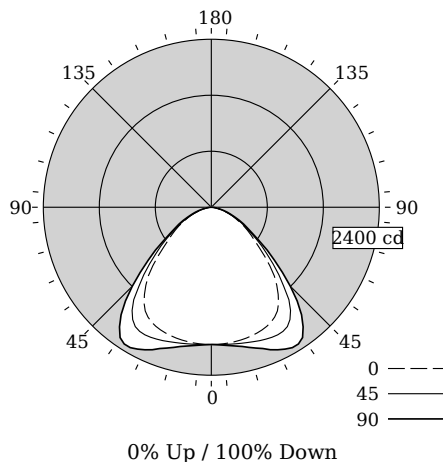

Total Output	5575 lm
Efficacy	119.9 lm/W
CCT	3787K
CRI	82
Distribution	0% Up / 100% Down
Spacing Criteria (0/90°)	1.37/1.65
UGR	17.3

UGR values measured at 4Hx8H, 0.25H

Fixture photometry has been conducted in accordance with IESNA LM-79-08

IES files for this and other photometric options can be downloaded online at www.lightingproducts.philips.com

Candela Distribution

Vertical Angle	Horizontal Angle					Zonal Lumens
	0	22.5	45	67.5	90	
0	1988	1988	1988	1988	1988	0
5	1984	1981	1991	1998	2005	190
15	1963	1974	2019	2063	2084	574
25	1910	1949	2069	2193	2243	958
35	1762	1832	2031	2240	2318	1259
45	1285	1341	1503	1679	1755	1158
55	749	771	837	910	947	764
65	397	403	423	442	467	430
75	167	170	181	190	197	196
85	31	33	39	43	46	46
90	0	0	0	0	0	0
95	0	0	0	0	0	0
105	0	0	0	0	0	0
115	0	0	0	0	0	0
125	0	0	0	0	0	0
135	0	0	0	0	0	0
145	0	0	0	0	0	0
155	0	0	0	0	0	0
165	0	0	0	0	0	0
175	0	0	0	0	0	0
180	0	0	0	0	0	0

Coefficients of Utilization (%)

RCR	Ceiling/Wall										
	70	50	30	10	70	50	30	50	30	10	0
0	119	119	119	119	116	116	116	111	111	111	100
1	110	106	102	99	108	104	100	100	97	94	87
2	101	94	88	83	99	92	87	89	84	80	74
3	93	84	76	70	91	82	75	79	73	68	64
4	86	75	67	60	84	73	66	71	64	59	56
5	79	67	59	53	77	66	58	64	57	52	49
6	73	61	52	46	71	60	52	58	51	46	43
7	68	55	47	41	66	54	46	53	46	40	38
8	63	50	42	37	62	50	42	48	41	36	34
9	59	46	38	33	58	46	38	44	38	33	31
10	55	43	35	30	54	42	35	41	34	30	28

Avg. Luminance (cd/m2)

Vertical Angle	Horizontal Angle		
	0	45	90
55	1905	2129	2411
65	1370	1460	1613
75	941	1021	1109
85	523	647	775

Philips Ledalite

Lighting facts
A Program of the U.S. DOE

Light Output (Lumens) 5575
Watts 46.5
Lumens per Watt (Efficacy) 119.89

Color Accuracy 82
Color Rendering Index (CRI)

Light Color 3787 (Bright White)
Correlated Color Temperature (CCT)

2700K 3000K 4500K 6500K

All results are according to IESNA LM-79-2008: Approved Method for the Electrical and Photometric Testing of Solid-State Lighting. The U.S. Department of Energy (DOE) verifies product test data and results.

Visit www.lightingfacts.com for the Label Reference Guide.

Registration Number: F46Z-1NBLDH (7/11/2016)
Model Number: 4224xxxxL8AC
Type: Luminaire - Troffer/Grid Ceiling

Electrical Specifications

Input Voltage	120V	277V
Input Power	46.5W	46.0W
Input Current	0.39A	0.17A
Power Factor	0.995	0.954
Total Harm. Distortion	6.1%	10.5%

Tested values – contact technical support for rated values. Off-state power zero unless certain controls are specified.

With SpaceWise DT, standby power <0.5W (120V) or <0.8W (277V).

© 2016 Philips Lighting Holding B.V. All rights reserved. Philips reserves the right to make changes in specifications and/or to discontinue any product at any time without notice or obligation and will not be liable for any consequences resulting from the use of this publication.
www.philips.com/luminaires



Philips Lighting, North America Corporation
200 Franklin Square Drive, Somerset, NJ 08873
Tel. 855-486-2216

Philips Lighting Canada Ltd.,
281 Hillmount Rd, Markham, ON, Canada L6C 2S3
Tel. 800-668-9008