



Recessed

SilkSpace

1'x4', 4000 lm
4000K



Project: _____
 Spec Type: _____
 Catalog No: 4214DxxxL8AD _____
 Qty _____
 Line Notes: _____

Philips Ledalite SilkSpace LED recessed combines LED Light Guide technology and Ledalite's revolutionary MesoOptics technology to deliver discrete, comfortable lighting with great performance and ultra low-glare.

Ordering guide

Product Type	Version	Configuration	Light Source *	CRI/CCT	Lumens *	Housing	Wiring †	Voltage	Driver
4214	D1		L	8A	D				
SilkSpace 1'x4' LED	D1 Standard T Grid	ST Standalone CR Continuous Row	L LED	8C CRI 80 3000K 8B CRI 80 3500K 8A CRI 80 4000K	K 1700 lm E 3000 lm D 4000 lm	S Standard C Chicago Plenum	7 1 cct Dimming N 1 cct Dimming + EM Batt Pack	1 120V 2 277V 3 347V	E Philips Advance 0-10V S Philips Advance SR

* Nominal values within a range. Consult photometry data for exact color temp, lumens & distribution.

† Not all wiring types are available with all configurations. Consult Philips Ledalite for a complete list of available options.

Upgrades & Accessories Please indicate with check mark.

- Drywall Kit Trim Mount
- Flex Whip (6' length)

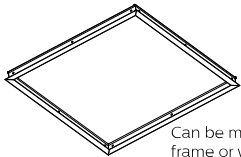

Can be mounted to wood frame or with hanger wire

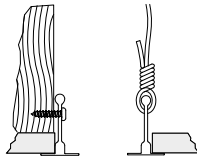

Integrated Controls Please indicate with check mark.

- Response Daylight Sensor Single Zone (DS)
- Philips Actilume Occupancy Sensor (DO) (includes field commissionable daylight sensor)
- SpaceWise DT Occupancy & Daylight Sensor (SZ)



SilkSpace

1'x4', 4000 lm
4000K

Housing

Sides and center spine: precision aluminum extrusion; end caps, back housing and driver cover: die-formed, 20 gauge cold-rolled steel, pre and post painted. Available in white. Multiple wire entrances are available (top or side) to allow continuous row mounting of fixtures.

Electrical

Factory pre-wired with driver safety disconnects. Dimming enabled as standard: 0-10V (1-100%). Philips Advance Xitanium Sensor Ready (SR), 5-100% (for SpaceWise). Output is Class 2 rated. Consult factory for a list of other options. LED boards and drivers are easily field replaceable, if required.

Lumen Maintenance

Lumen maintenance of the LEDs has been tested by the manufacturer in accordance with IESNA LM-80-08. At an ambient temperature of 25°C, the LED lumen maintenance expectation is L80(12K)>72,000h according to IES TM-21-11 Addendum A Reported methodology.

Controls

Available with the following integrated controls:
Response daylight sensor (for single zone).
Philips Actilume occupancy sensor (includes field commissionable daylight).
SpaceWise DT occupancy & daylight sensor w/ advanced grouping & dwell time.
SpaceWise DT commissioning via Android phone and Philips Field App. Compatible dimming wireless wall switches are available. For more information, please refer to www.philips.com/spacewise

Weight

Maximum 28lbs (2x4); 21lbs (1x4); 15lbs (2x2).

Mounting

Fixtures are factory pre-wired and tested for all circuits and emergency battery packs. Compatible with 15/16" lay-in acoustical ceilings using exposed grid suspension (NEMA type G). For 9/16" slot T-grid ceilings, fixture will sit 5/16" above bottom of Tee. Optional armored cable flex whips are supplied in 6' lengths.

Warranty

Five-year luminaire limited warranty including LED boards and driver.

USA: <http://www.usa.lighting.philips.com/support/support/warranty>

Canada: <http://www.lighting.philips.ca/support/support/warranty>

Certifications

SilkSpace luminaires are DesignLights Consortium® qualified. Please see the DLC QPL list for exact catalog numbers (<http://www.designlights.org/QPL>)

Environment

Rated for dry & damp locations in operating in ambient temperatures of 25°C.

General Notes

Many luminaire components, such as reflectors, refractors, lenses, sockets, lamp holders, and LEDs are made from various types of plastics which can be adversely affected by airborne contaminants. If sulfur based chemicals, petroleum based products, cleaning solutions, or other contaminants are expected in the intended area of use, consult factory for compatibility. Damage caused by sulfur, chlorine, petroleum based solution or other contaminants are not covered under warranty.

Optical System

The optical system is comprised of arrays of LEDs edge-lighting a low profile light guide panel. The microstructured surface of the light guide panel optimizes the light extraction creating a homogenously luminous appearance. Light is then controlled by MesoOptics film suppressing the high-angle light creating an ultra low-glare bat-wing distribution.

Approvals

Certified to UL, CSA & IES Standards. City of Chicago Approved CCEA (housing option C).

Due to continuing product improvements, Philips Ledalite reserves the right to change the specifications without notice.

Options and Details

Mounting

Integrates with most common T-Grid ceiling types

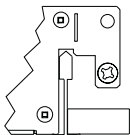

Flat T-Grid

Works with 9/16" & 15/16" flat T-Grid ceilings

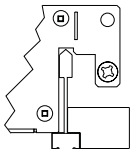

Slot T-Grid

Can also be used with slot T-Grid ceilings. For 9/16" slot T-grid ceilings, fixture will sit 5/16" above bottom of T-Bar.

Cross Section

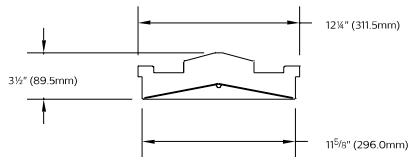

Lens View

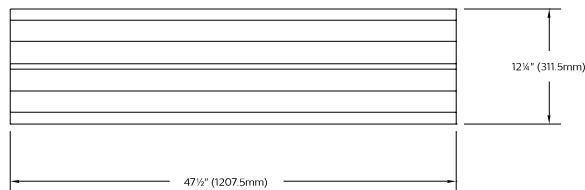

Side View



SilkSpace

1'x4', 4000 lm
4000K

Photometry

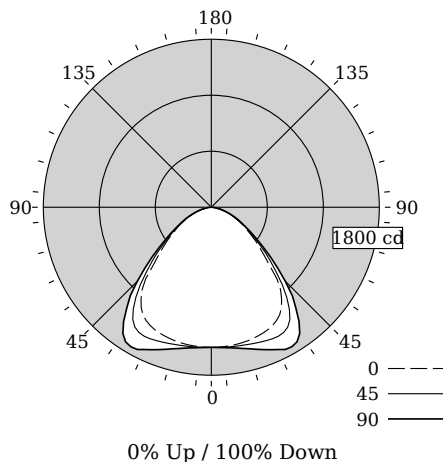

Total Output	4121 lm
Efficacy	109.6 lm/W
CCT	3766K
CRI	82
Distribution	0% Up / 100% Down
Spacing Criteria (0/90°)	1.37/1.58
UGR	18.7

UGR values measured at 4Hx8H, 0.25H

Fixture photometry has been conducted in accordance with IESNA LM-79-08

IES files for this and other photometric options can be downloaded online at www.lightingproducts.philips.com

Candela Distribution

Vertical Angle	Horizontal Angle					Zonal Lumens
	0	22.5	45	67.5	90	
0	1524	1524	1524	1524	1524	0
5	1509	1519	1525	1533	1536	146
15	1493	1510	1541	1572	1583	437
25	1454	1491	1573	1659	1690	728
35	1347	1404	1532	1658	1695	943
45	967	1006	1092	1179	1206	838
55	534	573	604	640	649	540
65	296	300	307	315	319	307
75	125	129	135	142	145	146
85	24	27	30	33	34	35
90	0	0	0	0	0	0
95	0	0	0	0	0	0
105	0	0	0	0	0	0
115	0	0	0	0	0	0
125	0	0	0	0	0	0
135	0	0	0	0	0	0
145	0	0	0	0	0	0
155	0	0	0	0	0	0
165	0	0	0	0	0	0
175	0	0	0	0	0	0
180	0	0	0	0	0	0

Coefficients of Utilization (%)

RCR	Ceiling: 80										
	Wall: 70		30		10		70		50		0
0	119	119	119	119	116	116	116	111	111	111	100
1	110	106	102	99	108	104	101	100	97	94	87
2	101	94	88	83	99	92	87	89	84	80	75
3	93	84	76	71	91	82	76	79	74	69	64
4	86	75	67	61	84	74	66	71	65	60	56
5	79	68	59	53	77	66	59	64	57	52	49
6	74	61	53	47	72	60	52	58	51	46	43
7	68	56	47	41	67	55	47	53	46	41	39
8	64	51	43	37	62	50	42	49	42	37	35
9	59	47	39	33	58	46	39	45	38	33	31
10	56	43	35	30	55	43	35	42	35	30	28

Avg. Luminance (cd/m2)

Vertical Angle	Horizontal Angle		
	0	45	90
55	2884	3265	3507
65	2171	2253	2343
75	1496	1622	1740
85	836	1078	1224

Philips Ledalite

Lighting facts
A Program of the U.S. DOE

Light Output (Lumens) 4121
Watts 37.6
Lumens per Watt (Efficacy) 109.6

Color Accuracy 82
Color Rendering Index (CRI)

Light Color 3766 (Bright White)
Correlated Color Temperature (CCT)

2700K 3000K 4500K 6500K

All results are according to IESNA LM-79-2008: Approved Method for the Electrical and Photometric Testing of Solid-State Lighting. The U.S. Department of Energy (DOE) verifies product test data and results.

Visit www.lightingfacts.com for the Label Reference Guide.

Registration Number: F46Z-TLG82Y (7/11/2016)
Model Number: 4214xxxxL8AD
Type: Luminaire - Troffer/Grid Ceiling

Electrical Specifications

Input Voltage	120V	277V
Input Power	37.6W	37.2W
Input Current	0.31A	0.14A
Power Factor	0.996	0.971
Total Harm. Distortion	5.5%	9.0%

Tested values – contact technical support for rated values. Off-state power zero unless certain controls are specified.

With SpaceWise DT, standby power <0.5W (120V) or <0.8W (277V).

