

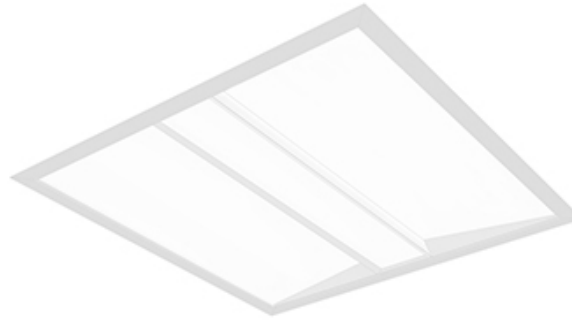

Recessed

Shine LED

600x600mm, 3000 lm
4000K



Project: _____
 Spec Type: _____
 Catalog No: 33M2xxxxL8AE _____
 Qty _____
 Line Notes: _____

A family of uniformly luminous fixtures, Philips Ledalite Shine recessed delivers outstanding performance for superior energy savings. Available in a wide variety of sizes, fluorescent or LED, Shine is a highly efficient and economical solution for any recessed lighting and energy challenge.

Ordering guide

Product Type	Version	Configuration	Light Source *	CRI/CCT	Lumens *	Housing	Wiring †	Voltage	Driver
33M2	D1	ST	L	8A	E				
Shine 600x600mm LED	D1 Standard T Grid	ST Standalone	L LED	8C CRI 80 3000K 8B CRI 80 3500K 8A CRI 80 4000K	E 3000 lm D 4000 lm	S Standard C Chicago Plenum	7 1 cct Dimming N 1 cct Dimming + EM Batt Pack	1 120V 2 277V 3 347V	E Philips Advance

* Nominal values within a range. Consult photometry data for exact color temp, lumens & distribution.
 † Not all wiring types are available with all configurations. Consult Philips Ledalite for a complete list of available options.

Upgrades & Accessories Please indicate with check mark.

Flex Whip (6' length)

Integrated Controls Please indicate with check mark.

- Response Daylight Sensor Single Zone (DS)
- Philips Actilume Occupancy Sensor (DO) (includes field commissionable daylight sensor)



Shine LED

600x600mm, 3000 lm

4000K

Weight

Maximum 40lbs

Optical System

Optical system consists of highly reflective painted interior reflectors and three flat acrylic lenses.

Standard Driver

Dimming: 0-10V (1-100%). Output is Class 2 rated. Consult factory for a list of other options.

Electrical

LED boards are easily field replaceable, if required. Fixtures are factory pre-wired and tested for all circuits and emergency battery packs; all leads pulled to a side access with cover plate. Optional armored cable flex whips are supplied in 6' lengths.

Lumen Maintenance

Lumen maintenance of the LEDs has been tested by the manufacturer in accordance with IESNA LM-80-08. At an ambient temperature of 25°C, the LED lumen maintenance expectation is L80(12K)>72,000h according to IES TM-21-11 Addendum A Reported methodology.

Housing

Die-formed, post-painted, 22 gauge cold-rolled steel. Wire entrance is positioned on top and the sides of housing to allow easy wiring access for installation.

Access to boards and drivers from below via side lens cavity. T-bar clips built into the luminaire ends for quick and easy installation. Optional perforated or solid filler panels for 20"x48" fixtures to accommodate 60" ceiling grid.

Finish

Housing and Frame: Post-painted, high quality powder coat. Available in white.

Warranty

Five-year luminaire limited warranty including LED boards and driver.

USA: <http://www.usa.lighting.philips.com/support/support/warranty>

Canada: <http://www.lighting.philips.ca/support/support/warranty>

Environment

Rated for dry & damp locations in operating in ambient temperatures of 25°C.

Approvals

Certified to UL & CSA Standards. City of Chicago Approved CCEA (housing option C).

General Notes

Many luminaire components, such as reflectors, refractors, lenses, sockets, lamp holders, and LEDs are made from various types of plastics which can be adversely affected by airborne contaminants. If sulfur based chemicals, petroleum based products, cleaning solutions, or other contaminants are expected in the intended area of use, consult factory for compatibility. Damage caused by sulfur, chlorine, petroleum based solution or other contaminants are not covered under warranty.

Mounting

Compatible with 15/16" lay-in acoustical ceilings using exposed grid suspension (NEMA type G). For 9/16" slot T-grid ceilings, fixture will sit 5/16" above bottom of Tee. Integrated tabs are provided for different T-grid heights.

Due to continuing product improvements, Philips Ledalite reserves the right to change the specifications without notice.

Options and Details

Mounting

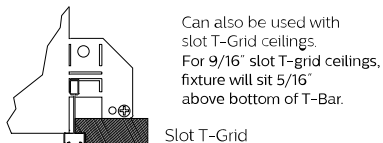
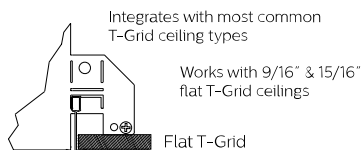

Ceiling types

Integrated mounting tabs can be field-adjusted to various T-Grid ceiling heights for fastening directly to the T-Bar and/or tied off to the building structure.

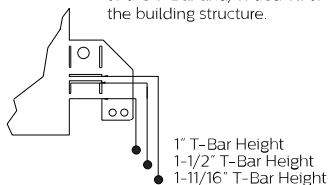

Cross Section

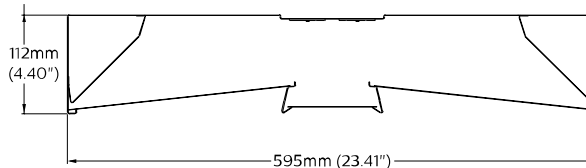

Lens View

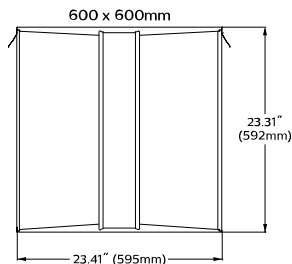

Shine LED

600x600mm, 3000 lm

4000K

Photometry

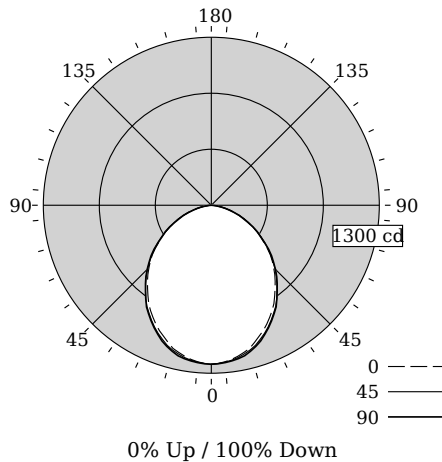

Total Output	3010 lm
Efficacy	112.7 lm/W
CCT	3900K
CRI	82
Distribution	0% Up / 100% Down
Spacing Criteria (0/90°)	1.15/1.18

Fixture photometry has been conducted in accordance with IESNA LM-79-08

IES files for this and other photometric options can be downloaded online at www.lightingproducts.philips.com

Candela Distribution

Vertical Angle	Horizontal Angle				Zonal Lumens
	0	22.5	45	67.5	
0	1231	1231	1231	1231	0
5	1216	1221	1219	1224	116
15	1147	1162	1160	1175	328
25	1015	1051	1040	1061	482
35	855	905	883	901	556
45	682	719	699	723	546
55	494	528	508	523	461
65	313	339	318	328	311
75	154	169	148	157	143
85	22	33	17	24	17
90	0	0	0	0	0
95	0	0	0	0	0
105	0	0	0	0	0
115	0	0	0	0	0
125	0	0	0	0	0
135	0	0	0	0	0
145	0	0	0	0	0
155	0	0	0	0	0
165	0	0	0	0	0
175	0	0	0	0	0
180	0	0	0	0	0

Coefficients of Utilization (%)

RCR	Ceiling				Wall				0		
	70	50	30	10	70	50	30	10			
0	119	119	119	119	116	116	116	111	111	111	100
1	110	105	101	97	107	103	99	99	96	93	85
2	100	92	86	80	97	90	84	87	82	78	72
3	92	82	74	67	89	80	73	77	71	66	61
4	84	73	64	58	82	71	63	69	62	56	53
5	78	65	56	50	75	64	56	62	55	49	46
6	72	59	50	44	70	58	50	56	49	43	41
7	67	53	45	39	65	53	45	51	44	39	36
8	62	49	41	35	61	48	40	47	40	35	32
9	58	45	37	32	57	44	37	43	36	31	29
10	55	42	34	29	53	41	34	40	33	29	27

Avg. Luminance (cd/m²)

Vertical Angle	Horizontal Angle		
	0	45	90
55	2623	2694	2661
65	2258	2293	2242
75	1810	1735	1681
85	765	594	587

Electrical Specifications

Input Voltage	120V	277V
Input Power	26.7W	26.4W
Input Current	0.22A	0.10A
Power Factor	0.997	0.966
Total Harm. Distortion	6.2%	13.2%

Tested values – contact technical support for rated values. Off-state power zero unless certain controls are specified.

© 2016 Philips Lighting Holding B.V. All rights reserved. Philips reserves the right to make changes in specifications and/or to discontinue any product at any time without notice or obligation and will not be liable for any consequences resulting from the use of this publication.
www.philips.com/luminaires



Philips Lighting, North America Corporation
 200 Franklin Square Drive, Somerset, NJ 08873
 Tel. 855-486-2216

Philips Lighting Canada Ltd.,
 281 Hillmount Rd, Markham, ON, Canada L6C 2S3
 Tel. 800-668-9008