

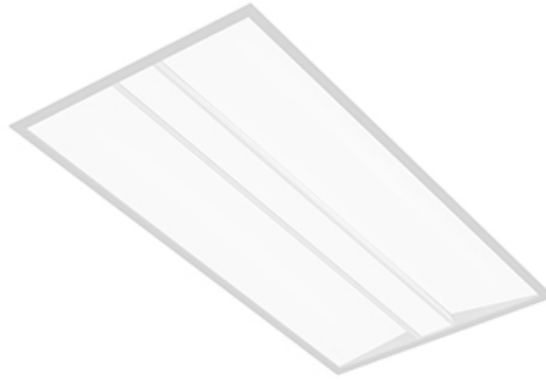

Recessed

Shine LED

600x1200mm, 5200 lm
3000K



Project: _____
 Spec Type: _____
 Catalog No: 33M4xxxxL8CC _____
 Qty _____
 Line Notes: _____

A family of uniformly luminous fixtures, Philips Ledalite Shine recessed delivers outstanding performance for superior energy savings. Available in a wide variety of sizes, fluorescent or LED, Shine is a highly efficient and economical solution for any recessed lighting and energy challenge.

Ordering guide

Product Type	Version	Configuration	Light Source *	CRI/CCT	Lumens *	Housing	Wiring †	Voltage	Driver
33M4	D1	ST	L	8C	C				
Shine 600x1200mm LED	D1 Standard T Grid	ST Standalone	L LED	8C CRI 80 3000K 8B CRI 80 3500K 8A CRI 80 4000K	D 4000 lm C 5200 lm A 6800 lm	S Standard C Chicago Plenum	7 1 cct Dimming N 1 cct Dimming + EM Batt Pack	1 120V 2 277V 3 347V	E Philips Advance

* Nominal values within a range. Consult photometry data for exact color temp, lumens & distribution.

† Not all wiring types are available with all configurations. Consult Philips Ledalite for a complete list of available options.

Upgrades & Accessories Please indicate with check mark.

Flex Whip (6' length)

Integrated Controls Please indicate with check mark.

Response Daylight Sensor Single Zone (DS)

Philips Actilume Occupancy Sensor (DO)
(includes field commissionable daylight sensor)



Shine LED

600x1200mm, 5200 lm

3000K

Weight

Maximum 40lbs

Optical System

Optical system consists of highly reflective painted interior reflectors and three flat acrylic lenses.

Standard Driver

Dimming: 0-10V (1-100%). Output is Class 2 rated. Consult factory for a list of other options.

Electrical

LED boards are easily field replaceable, if required. Fixtures are factory pre-wired and tested for all circuits and emergency battery packs; all leads pulled to a side access with cover plate. Optional armored cable flex whips are supplied in 6' lengths.

Lumen Maintenance

Lumen maintenance of the LEDs has been tested by the manufacturer in accordance with IESNA LM-80-08. At an ambient temperature of 25°C, the LED lumen maintenance expectation is L80(12K)>72,000h according to IES TM-21-11 Addendum A Reported methodology.

Housing

Die-formed, post-painted, 22 gauge cold-rolled steel. Wire entrance is positioned on top and the sides of housing to allow easy wiring access for installation. Access to boards and drivers from below via side lens cavity. T-bar clips built into the luminaire ends for quick and easy installation. Optional perforated or solid filler panels for 20"x48" fixtures to accommodate 60" ceiling grid.

Finish

Housing and Frame: Post-painted, high quality powder coat. Available in white.

Warranty

Five-year luminaire limited warranty including LED boards and driver.

USA: <http://www.usa.lighting.philips.com/support/support/warranty>

Canada: <http://www.lighting.philips.ca/support/support/warranty>

Environment

Rated for dry & damp locations in operating in ambient temperatures of 25°C.

Approvals

Certified to UL & CSA Standards. City of Chicago Approved CCEA (housing option C).

General Notes

Many luminaire components, such as reflectors, refractors, lenses, sockets, lamp holders, and LEDs are made from various types of plastics which can be adversely affected by airborne contaminants. If sulfur based chemicals, petroleum based products, cleaning solutions, or other contaminants are expected in the intended area of use, consult factory for compatibility. Damage caused by sulfur, chlorine, petroleum based solution or other contaminants are not covered under warranty.

Mounting

Compatible with 15/16" lay-in acoustical ceilings using exposed grid suspension (NEMA type G). For 9/16" slot T-grid ceilings, fixture will sit 5/16" above bottom of Tee. Integrated tabs are provided for different T-grid heights.

Due to continuing product improvements, Philips Ledalite reserves the right to change the specifications without notice.

Options and Details

Mounting

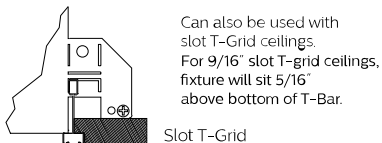
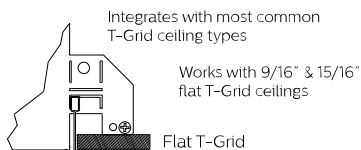

Ceiling types

Integrated mounting tabs can be field-adjusted to various T-Grid ceiling heights for fastening directly to the T-Bar and/or tied off to the building structure.

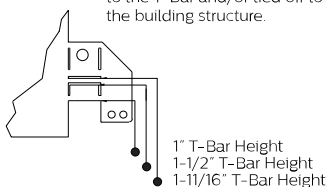

Cross Section

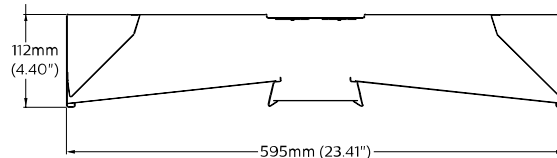

Lens View

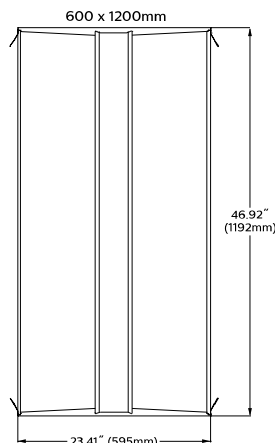

Shine LED

600x1200mm, 5200 lm
3000K

Photometry

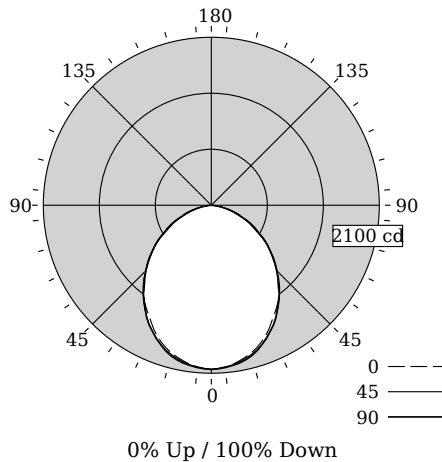

Total Output	5057 lm
Efficacy	111.9 lm/W
CCT	2995K
CRI	81
Distribution	0% Up / 100% Down
Spacing Criteria (0/90°)	1.15/1.18

Fixture photometry has been conducted in accordance with IESNA LM-79-08

IES files for this and other photometric options can be downloaded online at www.lightingproducts.philips.com

Candela Distribution

Vertical Angle	Horizontal Angle				Zonal Lumens
	0	22.5	45	67.5	
0	2052	2052	2052	2052	0
5	2027	2036	2033	2042	193
15	1914	1938	1931	1964	547
25	1706	1754	1741	1775	805
35	1459	1516	1474	1503	930
45	1159	1216	1166	1198	914
55	845	900	856	874	849
65	551	585	547	557	524
75	267	300	256	270	243
85	45	61	31	43	25
90	0	0	0	0	0
95	0	0	0	0	0
105	0	0	0	0	0
115	0	0	0	0	0
125	0	0	0	0	0
135	0	0	0	0	0
145	0	0	0	0	0
155	0	0	0	0	0
165	0	0	0	0	0
175	0	0	0	0	0
180	0	0	0	0	0

Coefficients of Utilization (%)

RCR	Ceiling				Wall				0	
	70	50	30	10	70	50	30	10		
0	119	119	119	119	116	116	116	111	111	100
1	109	105	101	97	107	103	99	98	95	85
2	100	92	86	80	97	90	84	87	82	72
3	91	81	74	67	89	80	73	77	71	61
4	84	72	64	57	82	71	63	69	62	53
5	77	65	56	50	75	64	56	62	55	46
6	72	59	50	44	70	58	50	56	49	40
7	67	53	45	39	65	53	44	51	44	36
8	62	49	40	35	60	48	40	47	40	32
9	58	45	37	31	57	44	37	43	36	29
10	54	41	34	29	53	41	34	40	33	26

Avg. Luminance (cd/m²)

Vertical Angle	Horizontal Angle		
	0	45	90
55	2190	2220	2200
65	1938	1926	1844
75	1535	1471	1396
85	768	520	432

Electrical Specifications

Input Voltage	120V	277V
Input Power	45.2W	44.8W
Input Current	0.38A	0.17A
Power Factor	0.997	0.961
Total Harm. Distortion	6.8%	14.0%

Tested values – contact technical support for rated values. Off-state power zero unless certain controls are specified.

© 2016 Philips Lighting Holding B.V. All rights reserved. Philips reserves the right to make changes in specifications and/or to discontinue any product at any time without notice or obligation and will not be liable for any consequences resulting from the use of this publication.
www.philips.com/luminaires



Philips Lighting, North America Corporation
200 Franklin Square Drive, Somerset, NJ 08873
Tel. 855-486-2216

Philips Lighting Canada Ltd.,
281 Hillmount Rd, Markham, ON, Canada L6C 2S3
Tel. 800-668-9008