

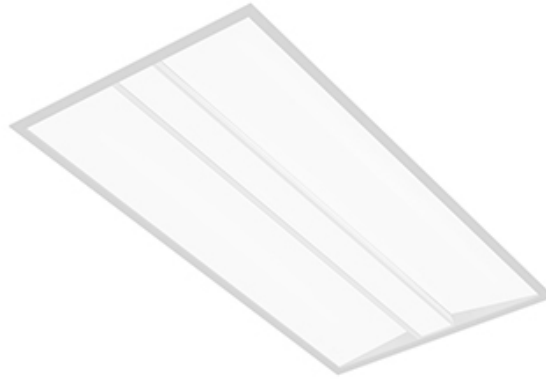

Recessed

Shine LED

20"x4', 6800 lm
3500K



Project: _____
 Spec Type: _____
 Catalog No: 3354xxxxL8BA _____
 Qty _____
 Line Notes: _____

A family of uniformly luminous fixtures, Philips Ledalite Shine recessed delivers outstanding performance for superior energy savings. Available in a wide variety of sizes, fluorescent or LED, Shine is a highly efficient and economical solution for any recessed lighting and energy challenge.

Ordering guide

Product Type	Version	Configuration	Light Source *	CRI/CCT	Lumens *	Housing	Wiring †	Voltage	Driver
3354	D1	ST	L	8B	A				
Shine 20"x4' LED	D1 Standard T Grid	ST Standalone	L LED	8C CRI 80 3000K 8B CRI 80 3500K 8A CRI 80 4000K	D 4000 lm C 5200 lm A 6800 lm	S Standard C Chicago Plenum	7 1 cct Dimming N 1 cct Dimming + EM Batt Pack	1 120V 2 277V 3 347V	E Philips Advance

* Nominal values within a range. Consult photometry data for exact color temp, lumens & distribution.

† Not all wiring types are available with all configurations. Consult Philips Ledalite for a complete list of available options.

Upgrades & Accessories Please indicate with check mark.

- Flex Whip (6' length)
- Solid Filler Panel (set of 2)
- Perforated Filler Panel/Air Return (set of 2)

Integrated Controls Please indicate with check mark.

- Response Daylight Sensor Single Zone (DS)
- Philips Actilume Occupancy Sensor (DO) (includes field commissionable daylight sensor)



Shine LED

20"x4', 6800 lm

3500K

Weight

Maximum 40lbs

Optical System

Optical system consists of highly reflective painted interior reflectors and three flat acrylic lenses.

Standard Driver

Dimming: 0-10V (1-100%). Output is Class 2 rated. Consult factory for a list of other options.

Electrical

LED boards are easily field replaceable, if required. Fixtures are factory pre-wired and tested for all circuits and emergency battery packs; all leads pulled to a side access with cover plate. Optional armored cable flex whips are supplied in 6' lengths.

Lumen Maintenance

Lumen maintenance of the LEDs has been tested by the manufacturer in accordance with IESNA LM-80-08. At an ambient temperature of 25°C, the LED lumen maintenance expectation is L80(12K)>72,000h according to IES TM-21-11 Addendum A Reported methodology.

Housing

Die-formed, post-painted, 22 gauge cold-rolled steel. Wire entrance is positioned on top and the sides of housing to allow easy wiring access for installation. Access to boards and drivers from below via side lens cavity. T-bar clips built into the luminaire ends for quick and easy installation. Optional perforated or solid filler panels for 20"x48" fixtures to accommodate 60" ceiling grid.

Finish

Housing and Frame: Post-painted, high quality powder coat. Available in white.

Warranty

Five-year luminaire limited warranty including LED boards and driver.

USA: <http://www.usa.lighting.philips.com/support/support/warranty>

Canada: <http://www.lighting.philips.ca/support/support/warranty>

Environment

Rated for dry & damp locations in operating in ambient temperatures of 25°C.

Approvals

Certified to UL & CSA Standards. City of Chicago Approved CCEA (housing option C).

General Notes

Many luminaire components, such as reflectors, refractors, lenses, sockets, lamp holders, and LEDs are made from various types of plastics which can be adversely affected by airborne contaminants. If sulfur based chemicals, petroleum based products, cleaning solutions, or other contaminants are expected in the intended area of use, consult factory for compatibility. Damage caused by sulfur, chlorine, petroleum based solution or other contaminants are not covered under warranty.

Mounting

Compatible with 15/16" lay-in acoustical ceilings using exposed grid suspension (NEMA type G). For 9/16" slot T-grid ceilings, fixture will sit 5/16" above bottom of Tee. Integrated tabs are provided for different T-grid heights.

Due to continuing product improvements, Philips Ledalite reserves the right to change the specifications without notice.

Options and Details

Mounting

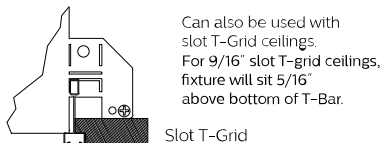
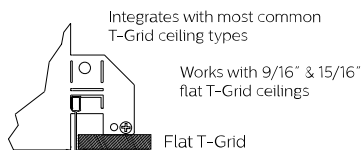

Ceiling types

Integrated mounting tabs can be field-adjusted to various T-Grid ceiling heights for fastening directly to the T-Bar and/or tied off to the building structure.

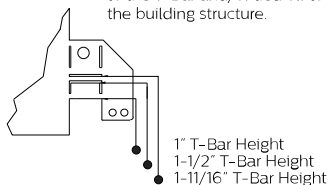

Cross Section

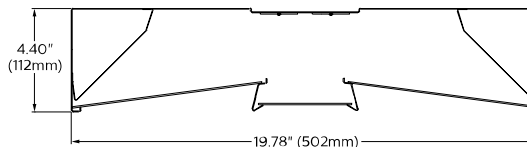

Lens View

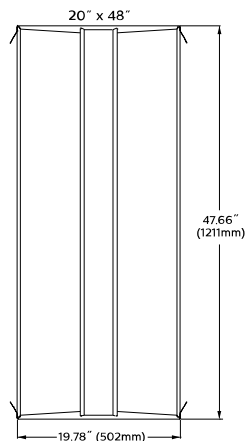

Shine LED

20"x4', 6800 lm
3500K

Photometry

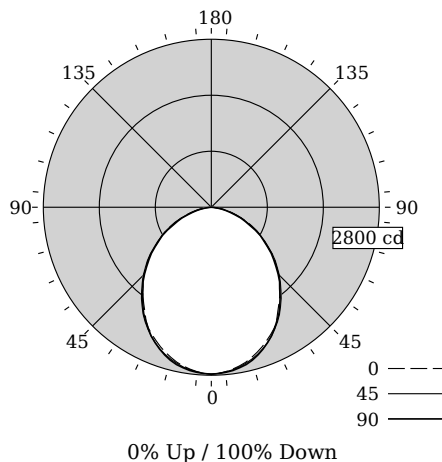

Total Output	6892 lm
Efficacy	114.9 lm/W
CCT	3348K
CRI	82
Distribution	0% Up / 100% Down
Spacing Criteria (0/90°)	1.17/1.18

Fixture photometry has been conducted in accordance with IESNA LM-79-08

IES files for this and other photometric options can be downloaded online at www.lightingproducts.philips.com

Candela Distribution

Vertical Angle	Horizontal Angle				Zonal Lumens
	0	22.5	45	67.5	
0	2783	2783	2783	2783	0
5	2750	2764	2755	2767	262
15	2593	2632	2619	2660	742
25	2341	2397	2371	2406	1096
35	1964	2060	2012	2044	1265
45	1590	1657	1604	1625	1375
55	1146	1211	1165	1203	1440
65	749	800	744	760	1511
75	364	401	351	366	1589
85	55	81	47	59	1672
90	0	0	0	0	1760
95	0	0	0	0	1850
105	0	0	0	0	1942
115	0	0	0	0	2036
125	0	0	0	0	2132
135	0	0	0	0	2230
145	0	0	0	0	2330
155	0	0	0	0	2432
165	0	0	0	0	2536
175	0	0	0	0	2642
180	0	0	0	0	2750

Coefficients of Utilization (%)

RCR	Ceiling				Wall				0	
	70	50	30	10	70	50	30	10		
0	119	119	119	119	116	116	116	111	111	100
1	109	105	101	97	107	103	99	98	95	85
2	100	92	86	80	97	90	84	87	82	72
3	91	81	73	67	89	80	72	77	71	61
4	84	72	64	57	82	71	63	69	62	53
5	77	65	56	50	75	64	56	62	54	46
6	72	59	50	44	70	58	49	56	49	40
7	66	53	45	39	65	52	44	51	44	36
8	62	49	40	35	60	48	40	47	40	32
9	58	45	37	31	57	44	37	43	36	29
10	54	41	34	28	53	41	33	40	33	26

Avg. Luminance (cd/m²)

Vertical Angle	Horizontal Angle		
	0	45	90
55	3492	3551	3476
65	3100	3076	2897
75	2458	2372	2162
85	1110	941	703

Electrical Specifications

Input Voltage	120V	277V
Input Power	60.0W	59.1W
Input Current	0.50A	0.22A
Power Factor	0.998	0.974
Total Harm. Distortion	5.4%	11.5%

Tested values – contact technical support for rated values. Off-state power zero unless certain controls are specified.

