

Wall
 Direct/Indirect
 1 T8 - Solid Housing

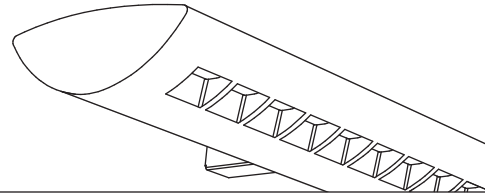

Project Name

Spec Type

Notes

Order Guide

Some combinations of product options may not be available. Consult factory for assistance with your specification.

9508	T01			-		-		-	
Product Series & Type Centris Wall	Lamping 1 T8	Lower Optics C Solid Baffle R Round Perf Baffle	Upper Optics N None	Run Length <i>Enter the total run length in feet (4ft increments)</i>	Wiring 1 1 cct 3 1 cct w/ Emergency cct 5 1 cct w/ Battery Pack 7 1 cct Dimming	Voltage 1 120V 2 277V 3 347V	Ballast E Standard Ballast	Color & Finish W Standard White C Factory Color X Custom Color	
		See details on reverse		See details on reverse	Consult website for complete list of standard wiring options		Consult website for ballast manufacturer information	Consult website for color and finish options	

Upgrades & Accessories

Please indicate with check mark.

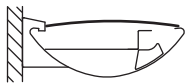
<input type="checkbox"/> Lamps Included	<input type="checkbox"/> Lamps Included and Installed
<input type="checkbox"/> Sculptured Endcap See details on reverse	<input type="checkbox"/> Dust Cover 

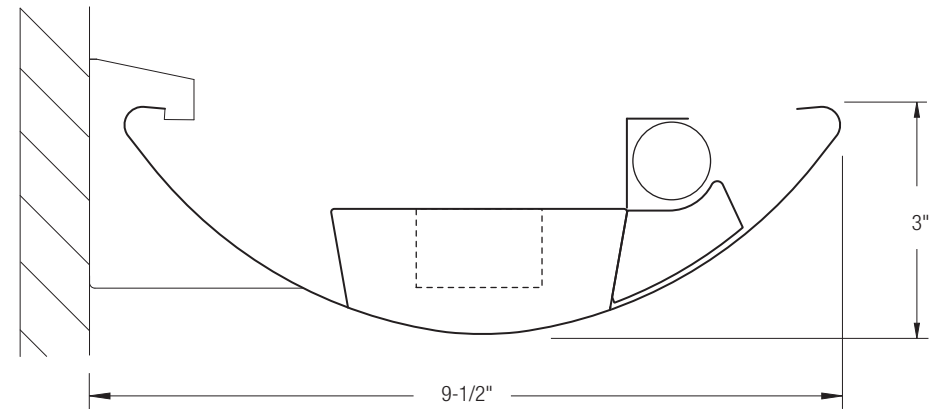

Centris®

Wall
Direct/Indirect
1 T8 - Solid Housing

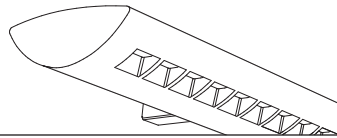

Photometry Optics RN Round Perf Baffle

Report Summary

Report # 2101677
Filename 9508T01CN-RN.ies
Efficiency 59.7%

Peak Candela Value* 418 @ 128°
Peak to Zenith Ratio* 1.7 : 1

* Between 90-180° vertical angle

Meets RP-1-04 recommendations for VDT-Normal spaces

Candela Distribution

Vertical Angle	Horizontal Angle					Zonal Lumens
	0	22.5	45	67.5	90	
0	423	423	423	423	423	
5	462	452	418	360	334	39
15	501	475	386	238	174	99
25	500	462	331	123	47	134
35	423	418	264	36	18	144
45	331	330	187	22	19	136
55	233	236	114	17	4	107
65	144	150	52	2	1	70
75	89	81	25	1	0	39
85	54	45	7	1	0	22
90	44	38	1	2	2	
95	112	98	16	10	12	50
105	210	189	58	26	26	104
115	312	284	102	46	41	148
125	404	315	139	73	63	170
135	404	313	173	110	88	162
145	368	291	202	154	127	140
155	317	280	226	196	179	108
165	289	273	242	221	214	70
175	265	260	251	243	240	24
180	252	252	252	252	252	

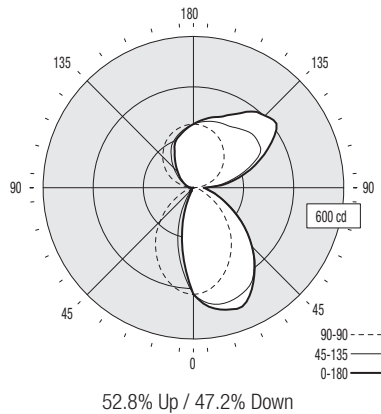

Coefficients of Utilization (%)

Ceiling:	Horizontal Angle											
	70				80				90			
Wall:	70	50	30	10	70	50	30	10	50	30	10	0
0 RCR	63	63	63	63	58	58	58	48	48	48	26	
1	57	55	53	51	53	50	48	42	40	39	22	
2	52	48	45	42	48	44	41	37	35	33	19	
3	48	43	38	35	44	39	35	33	30	28	16	
4	44	38	33	30	40	35	31	29	26	24	14	
5	40	34	29	26	37	31	27	26	23	21	12	
6	37	30	26	22	34	28	24	24	20	18	11	
7	34	27	23	19	32	25	21	21	18	16	10	
8	32	25	20	17	29	23	19	20	16	14	9	
9	30	23	18	15	27	21	17	18	15	13	8	
10	28	21	17	14	26	19	16	17	14	11	7	

Based on a floor reflectance of 0.2

Avg. Luminance (cd/m²)

Vertical Angle	Horizontal Angle		
	0	45	90
55	1090	810	19
65	780	501	5
75	595	394	0
85	490	327	0

IES files for this and other photometric options can be downloaded online at www.ledalite.com

Additional Information

Modules

Module length excludes endcaps.
Nominal mount spacing for individually mounted modules.

Module	Nominal Length
4ft	4' 0"
8ft	8' 0"
12ft	12' 0"

Refer to installation instructions for exact mount spacing

Endcap

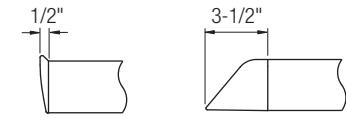

Flat (Standard)

Sculptured

Mounting Hardware

- Mounts variable within 6" of end or joint.
 - Minimum one mount per fixture end or joint.
- Note:** Mount is not continuous, and therefore fixture is not flush with wall.

Lower Optics

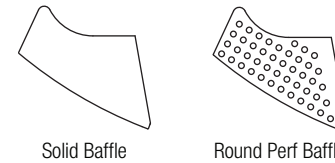

Solid Baffle

Round Perf Baffle

Specifications

Due to continuing product improvements, Ledalite reserves the right to change specifications without notice.

Housing

Die-formed 20 gauge cold-rolled steel.

Weight

3.0 lb/ft.

Optical System

Direct/Indirect: Constructed of 96% reflective white steel, and produces an asymmetric direct/indirect distribution. Baffles are white blades spaced 2-7/16" apart and are 3/4" deep (18 cells per 4ft section). Perforation of baffles and housing is optional. Perforated housing options use additional acrylic overlay.

Semi-indirect: Constructed of highly specular aluminum, 96% reflective white steel, and a perforated optical filter with acrylic overlay to produce an asymmetric semi-indirect distribution.

Indirect: Constructed of highly specular aluminum and 96% reflective white steel to produce an asymmetric indirect distribution.

Endcaps

Die-cast endcap or optional die-cast sculptured endcap.

Joints

Self-aligning joining system with hands-free pre-joining wire access.

Mounting

Brackets attach to existing structure, variable within 6" of end or joint.

Electrical

All luminaires shall be factory pre-wired to section ends with quick-wire connectors.

Ballast

Electronic.

Approvals

Certified to UL & CSA standards.

Finish

High-quality powder coat. Available in Ledalite Standard White (textured matte finish), and a selection of other factory and customer-specified colors. Consult factory for details.