

Wall  
 Direct/Indirect  
 1 T5HO - Perf Housing

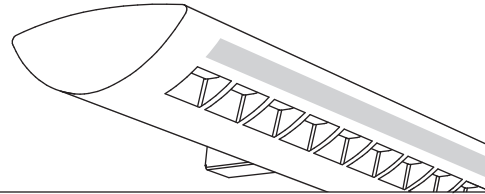

Project Name

Spec Type

Notes



## Order Guide

Some combinations of product options may not be available. Consult factory for assistance with your specification.

9508	H01			-		-		-		-	
Product Series & Type Centris Wall	Lamping 1 T5HO	Lower Optics <b>M</b> Round Perf Housing / Solid Baffle <b>T</b> Round Perf Housing / Round Perf Baffle <b>U</b> Slot Perf Housing / Solid Baffle <b>Z</b> Slot Perf Housing / Round Perf Baffle  See details on reverse	Upper Optics <b>N</b> None	Run Length <i>Enter the total run length in feet (4ft increments)</i>  See details on reverse	Wiring <b>1</b> 1 cct <b>3</b> 1 cct w/ Emergency cct <b>5</b> 1 cct w/ Battery Pack <b>7</b> 1 cct Dimming  Consult website for complete list of standard wiring options	Voltage <b>1</b> 120V <b>2</b> 277V <b>3</b> 347V	Ballast <b>E</b> Standard Ballast  Consult website for ballast manufacturer information	Color & Finish <b>W</b> Standard White <b>C</b> Factory Color <b>X</b> Custom Color  Consult website for color and finish options			

## Upgrades & Accessories

Please indicate with check mark.

Lamps Included  Lamps Included and Installed

Sculptured Endcap  
See details on reverse

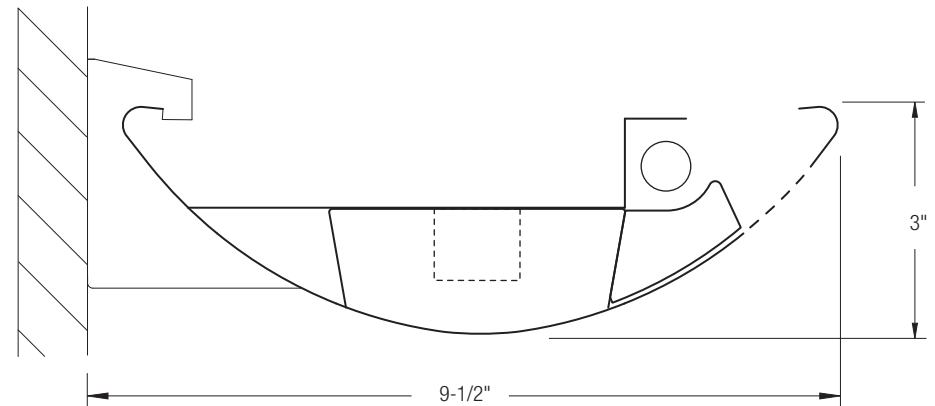

Wall  
 Direct/Indirect  
 1 T5HO - Perf Housing

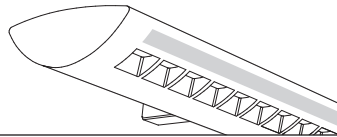

**Photometry** Optics UN Slot Perf Housing / Solid Baffle

**Report Summary**

**Report #** 2101680  
**Filename** 9508H01UN-ZN.ies  
**Efficiency** 66.5%

**Peak Candela Value\*** 771 @ 123°  
**Peak to Zenith Ratio\*** 2.3 : 1

\* Between 90-180° vertical angle

**Candela Distribution**

Vertical Angle	Horizontal Angle					Zonal Lumens
	0	22.5	45	67.5	90	
0	674	674	674	674	674	
5	733	716	668	614	579	63
15	804	756	618	391	247	159
25	889	751	534	157	17	216
35	850	751	428	31	34	254
45	675	655	315	41	40	250
55	465	481	198	33	12	207
65	290	301	89	5	1	138
75	187	164	44	1	2	79
85	120	92	13	1	1	47
90	119	84	1	3	3	
95	186	159	28	15	12	87
105	404	398	98	48	44	203
115	669	570	157	87	77	289
125	769	583	204	135	113	307
135	725	578	245	192	155	278
145	660	510	279	241	215	228
155	540	464	306	240	265	163
165	460	412	322	260	249	96
175	373	359	331	308	299	32
180	333	333	333	333	333	

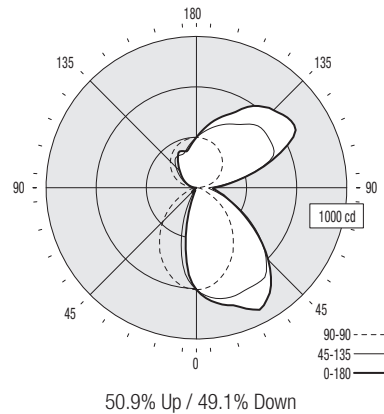

**Coefficients of Utilization (%)**

Ceiling: Wall:	80				70				50				0	
	70	50	30	10	70	50	30	10	50	30	10	0	0	
0 RCR	70	70	70	70	64	64	64	53	53	53	30			
1	64	61	58	56	59	56	54	47	45	44	25			
2	58	53	49	46	53	49	46	41	38	36	21			
3	53	47	42	38	49	43	39	36	33	31	18			
4	49	42	36	32	44	38	34	32	29	26	15			
5	45	37	32	28	41	34	30	29	25	23	13			
6	41	33	28	24	38	31	26	26	22	20	12			
7	38	30	25	21	35	28	23	24	20	17	11			
8	35	27	22	19	32	25	21	21	18	15	9			
9	33	25	20	17	30	23	19	20	16	14	8			
10	31	23	18	15	28	21	17	18	15	12	8			

Based on a floor reflectance of 0.2

**Avg. Luminance (cd/m²)**

Vertical Angle	Horizontal Angle		
	0	45	90
55	2175	1407	56
65	1571	858	5
75	1249	693	13
85	1088	608	9

IES files for this and other photometric options can be downloaded online at [www.ledalite.com](http://www.ledalite.com)

**Additional Information**

**Modules**

Module length excludes endcaps.  
 Nominal mount spacing for individually mounted modules.

Module	Nominal Length
4ft	4' 0"
8ft	8' 0"
12ft	12' 0"

Refer to installation instructions for exact mount spacing

**Endcap**

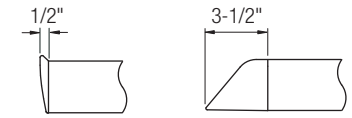

Flat (Standard)

Sculptured

**Mounting Hardware**

- Mounts variable within 6" of end or joint.
  - Minimum one mount per fixture end or joint.
- Note:** Mount is not continuous, and therefore fixture is not flush with wall.

**Lower Optics**

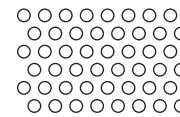

Round Perf Housing

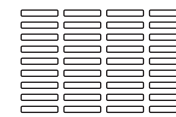

Slot Perf Housing

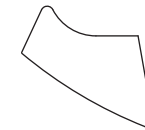

Solid Baffle

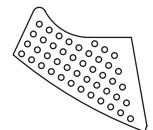

Round Perf Baffle

**Specifications**

Due to continuing product improvements, Ledalite reserves the right to change specifications without notice.

**Housing**

Die-formed 20 gauge cold-rolled steel.

**Weight**

3.0 lb/ft.

**Optical System**

Direct/Indirect: Constructed of 96% reflective white steel, and produces an asymmetric direct/indirect distribution. Baffles are white blades spaced 2-7/16" apart and are 3/4" deep (18 cells per 4ft section). Perforation of baffles and housing is optional. Perforated housing options use additional acrylic overlay.

Semi-indirect: Constructed of highly specular aluminum, 96% reflective white steel, and a perforated optical filter with acrylic overlay to produce an asymmetric semi-indirect distribution.

Indirect: Constructed of highly specular aluminum and 96% reflective white steel to produce an asymmetric indirect distribution.

**Endcaps**

Die-cast endcap or optional die-cast sculptured endcap.

**Joints**

Self-aligning joining system with hands-free pre-joining wire access.

**Mounting**

Brackets attach to existing structure, variable within 6" of end or joint.

**Electrical**

All luminaires shall be factory pre-wired to section ends with quick-wire connectors.

**Ballast**

Electronic.

**Approvals**

Certified to UL & CSA standards.

**Finish**

High-quality powder coat. Available in Ledalite Standard White (textured matte finish), and a selection of other factory and customer-specified colors. Consult factory for details.