

# LEDALITE - TRUGROOVE SUSPENDED

**TEST DATE:** 04 May 2021 **CATALOG NO:** 29x1L95030QN

<b>Lamp Type:</b>	LED	<b>Description:</b>	DIRECT MESO 3000LM 950
<b>No. of Lamps:</b>	88		
<b>Rated Lamp Lumens:</b>	-1	<b>Flux (lm), Efficiency (%):</b>	3316 lm 100%
<b>Input Watts:</b>	120 VAC 32.9	<b>Up/Dn Ratio, Efficacy (lm/W):</b>	100% Down / 0% Up 100.8
<b>CIE-IES Classification:</b>	Direct	<b>Report:</b>	LNG01217

CANDELA DISTRIBUTION						
	Flux					Lumens
	0	22.5	45	67.5	90	
0	1153	1153	1153	1153	1153	
5	1131	1147	1160	1172	1180	111
15	1069	1112	1180	1241	1267	333
25	958	1033	1167	1268	1302	529
35	815	907	1071	1158	1175	644
45	657	739	877	916	910	638
55	489	538	619	623	613	521
65	308	326	360	357	352	342
75	140	145	157	157	156	163
85	26	26	29	30	30	36
90	0	0	0	0	0	
95	0	0	0	0	0	0
105	0	0	0	0	0	0
115	0	0	0	0	0	0
125	0	0	0	0	0	0
135	0	0	0	0	0	0
145	0	0	0	0	0	0
155	0	0	0	0	0	0
165	0	0	0	0	0	0
175	0	0	0	0	0	0
180	0	0	0	0	0	0

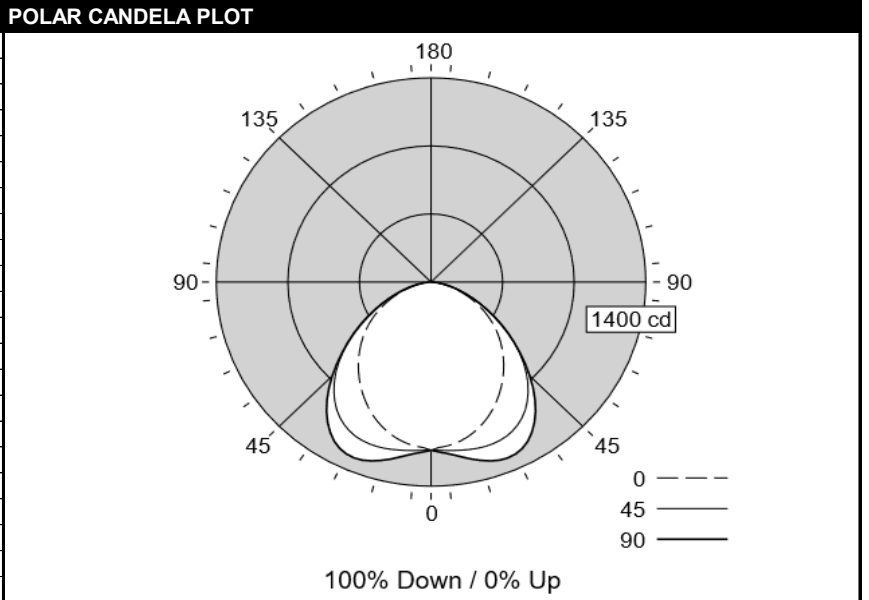

CHARACTERISTICS				COEFFICIENTS OF UTILIZATION (%)												
RP1	None			Pc---	80				70			50			0	
Direct: Peak Candela & Angle (0°)	1153.2	0.0		Pw---	70	50	30	10	70	50	30	50	30	10	0	
Direct: Peak Candela & Angle (90°)	1306.3	22.5		RCR												
Spacing Criteria (0°, 90°, 180°)	1.16	1.51	N/A	0	119	119	119	119	116	116	116	111	111	111	100	
Beam (H, V), Field (H, V)	107.3	94.2	154.0	149.8	1	110	105	101	98	107	103	99	99	96	93	85
Indirect: Peak Candela & Angle(°)	N/A	N/A			2	100	92	86	81	98	91	85	87	82	78	72
Indirect: Zenith Candela, Peak to Zenith	N/A	N/A			3	92	82	74	68	89	80	73	77	71	66	61
Luminous Width, Length, Height (ft)	0.25	4.00	0.00		4	84	73	64	58	82	71	63	69	62	56	53
DLC, UGR (4H x 8H, 1.0H), MDER	N/A	23.5	0.809		5	77	65	56	50	75	64	56	62	55	49	46
x, y, CCT, D <sub>uv</sub>	0.3420	0.3512	5121	0.0011	6	72	59	50	44	70	58	49	56	48	43	40
CRI (R <sub>a</sub> ), R <sub>g</sub> , G <sub>a</sub> , C <sub>g</sub>	93	68	99	94	7	66	53	45	39	65	52	44	51	43	38	36
TM-30-18 R <sub>f</sub> , R <sub>h1</sub> , R <sub>g</sub> , R <sub>mh1</sub>	90	89	100	-5%	8	62	48	40	34	60	48	40	46	39	34	32
120V: P(W), I(A), THD(%), PF	32.9	0.276	7.9	0.995	9	58	44	36	31	56	44	36	43	36	31	29
277V: P(W), I(A), THD(%), PF	32.8	0.123	13.3	0.963	10	54	41	33	28	53	41	33	40	33	28	26
347V: P(W), I(A), THD(%), PF	32.0	0.095	7.3	0.974	*Based on a floor reflectance of 0.2											

ZONAL LUMENS (lm)			
Zone	Lumens	%Fixture	%Lamp
0-30	973	29.3%	29.3%
0-40	1617	48.8%	48.8%
0-60	2776	83.7%	83.7%
0-90	3316	100.0%	100.0%
90-130	0	0.0%	0.0%
90-150	0	0.0%	0.0%
90-180	0	0.0%	0.0%
0-180	3316	100.0%	100.0%

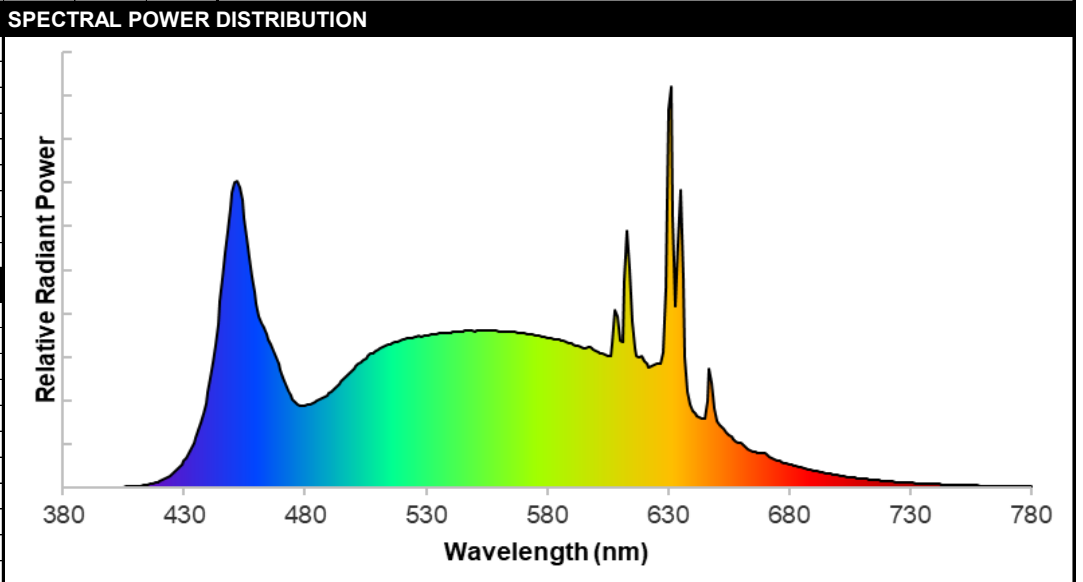

AVG LUMINANCE (cd/m <sup>2</sup> )			
	0	45	90
0	12408	12408	12408
5	12211	12529	12745
15	11909	13148	14112
25	11373	13849	15459
35	10704	14071	15440
45	10001	13350	13852
55	9179	11605	11501
65	7847	9166	8957
75	5820	6510	6490
85	3222	3568	3716

# Output of GLA Calculation Tool for CIE 13.3 CRI and Associated CRI-based Colour Rendition Properties

<b>Test Number:</b>	T20201109	<b>Manufacturer:</b>	Ledalite by Signify
<b>Date:</b>	27 Aug 2020	<b>Model:</b>	TruGroove Suspended

<b>Correlated Colour Temperature (<math>T_{cp}</math>) in K</b>	5121	<b>CIE1931 chromaticity coordinate, <math>x</math></b>	0.3420
<b>Distance to Blackbody Locus (<math>D_{uv}</math>)</b>	0.0011	<b>CIE1931 chromaticity coordinate, <math>y</math></b>	0.3512
<b>General Colour Rendering Index (<math>R_a</math>)</b>	93	<b>CIE1976 chromaticity coordinate, <math>u'</math></b>	0.2095
<b>Red Rendering Index (<math>R_9</math>)</b>	68	<b>CIE1976 chromaticity coordinate, <math>v'</math></b>	0.4840
<b>Colour Gamut Index (<math>G_a</math>)</b>	99		
<b>Red Chroma Index (<math>C_9</math>)</b>	94		

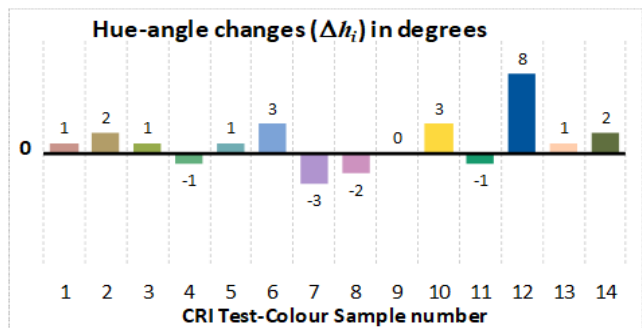
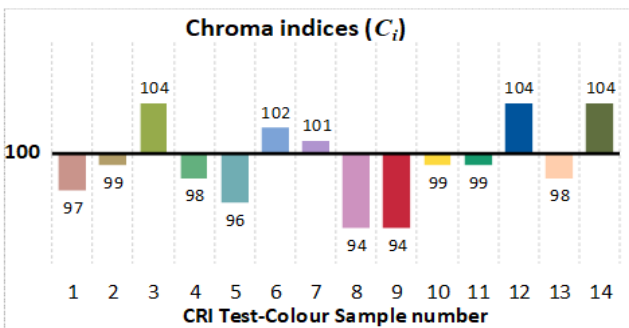
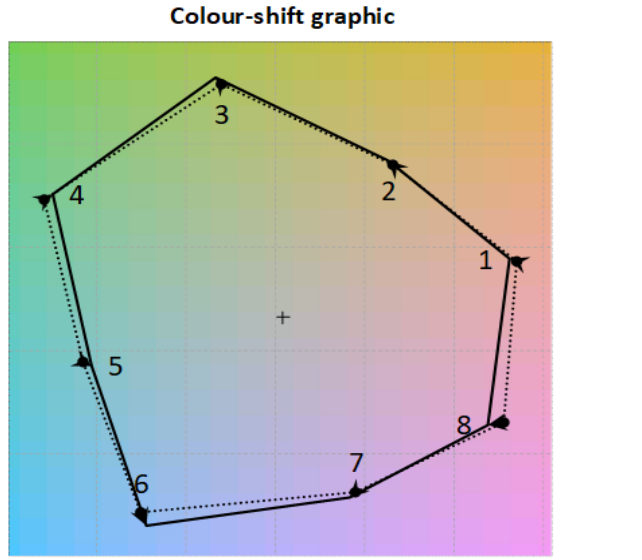
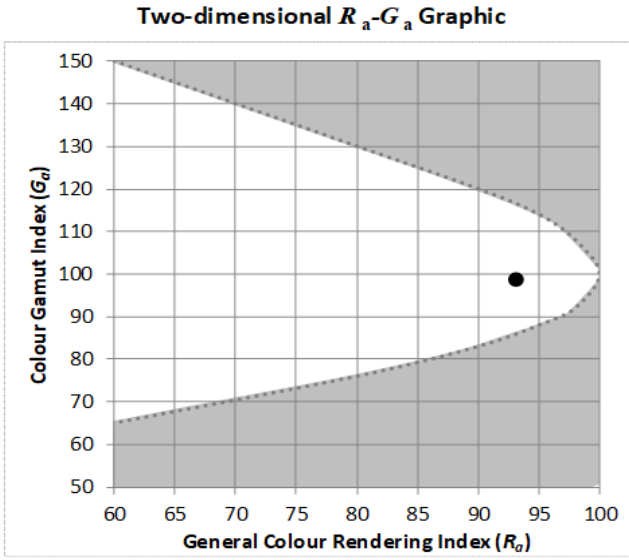
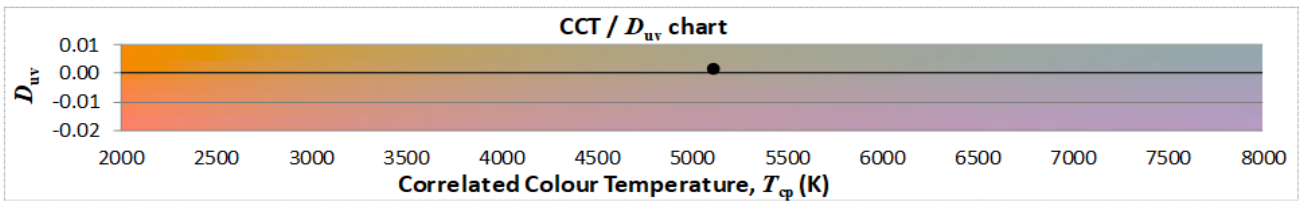
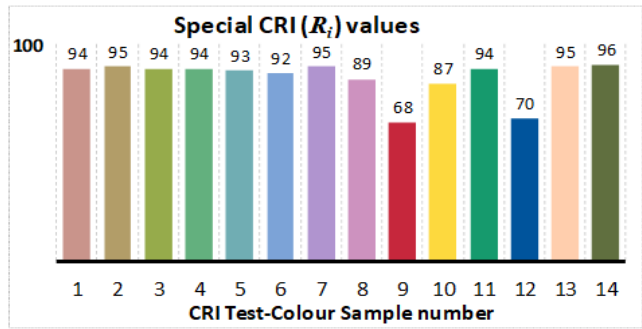
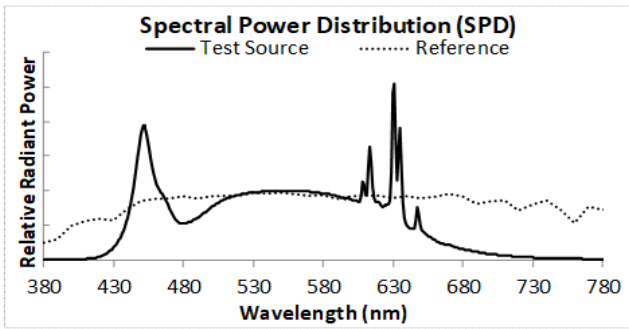

# ANSI/IES TM-30-18 Color Rendition Report

Source: T20201109

Manufacturer: Ledalite by Signify

Date: 27 Aug 2020

Model: TruGroove Suspended

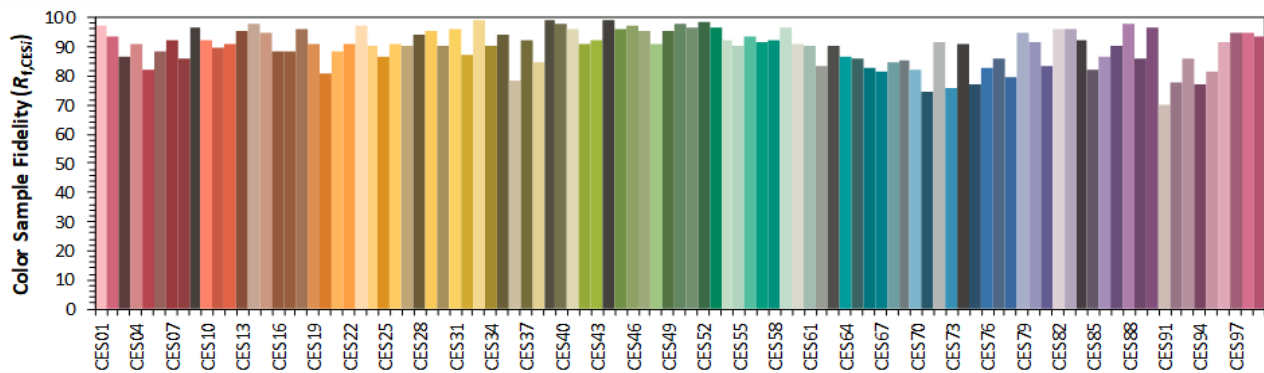
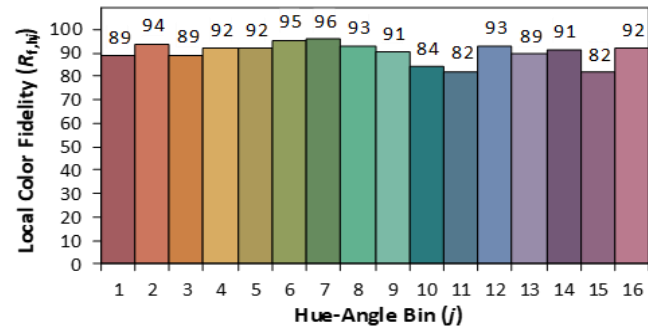
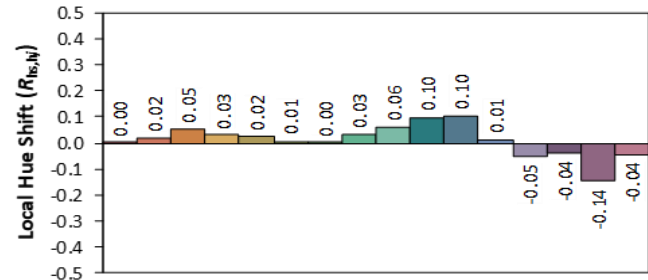
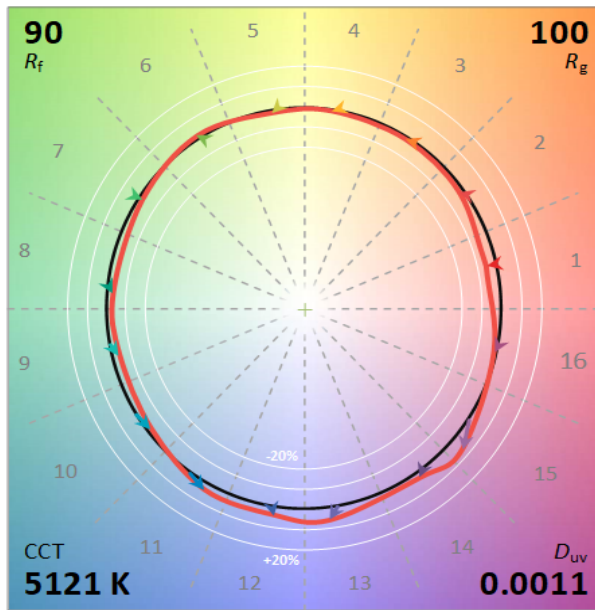
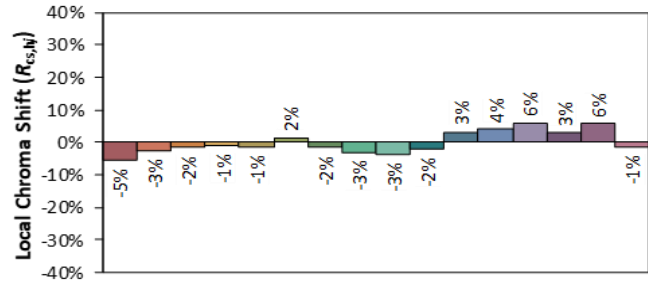
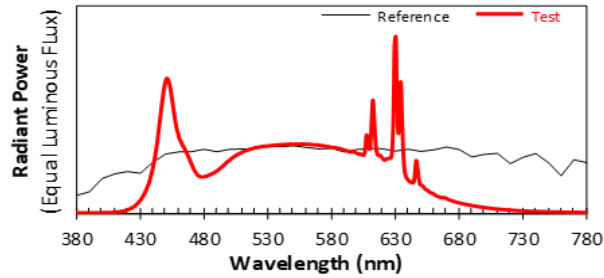

Notes: This is a recommended method for displaying ANSI/IES TM-30-18 information.

x 0.3420

y 0.3512

u' 0.2095

v' 0.4840

### SPECTRAL POWER DISTRIBUTION

λ (nm)	SPD	λ (nm)	SPD	λ (nm)	SPD	λ (nm)	SPD	λ (nm)	SPD	λ (nm)	SPD	λ (nm)	SPD	λ (nm)	SPD	λ (nm)	SPD
380	0.00010	425	0.00600	470	0.05370	515	0.06580	560	0.07190	605	0.06060	650	0.03040	695	0.00680	740	0.00160
381	0.00020	426	0.00690	471	0.05050	516	0.06650	561	0.07180	606	0.06070	651	0.02900	696	0.00680	741	0.00160
382	0.00020	427	0.00800	472	0.04730	517	0.06670	562	0.07180	607	0.06610	652	0.02840	697	0.00630	742	0.00150
383	0.00020	428	0.00920	473	0.04480	518	0.06700	563	0.07170	608	0.08130	653	0.02680	698	0.00620	743	0.00150
384	0.00020	429	0.01060	474	0.04250	519	0.06750	564	0.07170	609	0.07850	654	0.02520	699	0.00600	744	0.00140
385	0.00020	430	0.01210	475	0.04070	520	0.06790	565	0.07150	610	0.06720	655	0.02420	700	0.00580	745	0.00140
386	0.00020	431	0.01380	476	0.03920	521	0.06820	566	0.07130	611	0.06690	656	0.02360	701	0.00560	746	0.00140
387	0.00030	432	0.01580	477	0.03830	522	0.06850	567	0.07130	612	0.09480	657	0.02240	702	0.00540	747	0.00130
388	0.00020	433	0.01800	478	0.03770	523	0.06850	568	0.07120	613	0.11790	658	0.02130	703	0.00520	748	0.00130
389	0.00010	434	0.02040	479	0.03750	524	0.06880	569	0.07110	614	0.10040	659	0.02080	704	0.00500	749	0.00120
390	0.00020	435	0.02320	480	0.03760	525	0.06920	570	0.07110	615	0.07640	660	0.02040	705	0.00490	750	0.00120
391	0.00010	436	0.02640	481	0.03790	526	0.06940	571	0.07070	616	0.06420	661	0.01960	706	0.00480	751	0.00120
392	0.00010	437	0.02980	482	0.03830	527	0.06960	572	0.07060	617	0.06040	662	0.01860	707	0.00460	752	0.00110
393	0.00020	438	0.03390	483	0.03870	528	0.06950	573	0.07050	618	0.05990	663	0.01780	708	0.00440	753	0.00110
394	0.00020	439	0.03870	484	0.03930	529	0.06990	574	0.07030	619	0.06020	664	0.01730	709	0.00430	754	0.00110
395	0.00020	440	0.04390	485	0.04000	530	0.06990	575	0.06990	620	0.05820	665	0.01680	710	0.00420	755	0.00100
396	0.00020	441	0.05030	486	0.04030	531	0.07000	576	0.06970	621	0.05670	666	0.01640	711	0.00410	756	0.00100
397	0.00020	442	0.05730	487	0.04110	532	0.07020	577	0.06970	622	0.05520	667	0.01600	712	0.00390	757	0.00100
398	0.00020	443	0.06570	488	0.04170	533	0.07060	578	0.06920	623	0.05580	668	0.01570	713	0.00380	758	0.00100
399	0.00020	444	0.07490	489	0.04240	534	0.07050	579	0.06910	624	0.05660	669	0.01590	714	0.00370	759	0.00090
400	0.00020	445	0.08550	490	0.04330	535	0.07080	580	0.06880	625	0.05690	670	0.01580	715	0.00350	760	0.00090
401	0.00030	446	0.09650	491	0.04410	536	0.07090	581	0.06860	626	0.05720	671	0.01500	716	0.00350	761	0.00080
402	0.00030	447	0.10810	492	0.04530	537	0.07100	582	0.06840	627	0.05720	672	0.01420	717	0.00330	762	0.00080
403	0.00030	448	0.11820	493	0.04630	538	0.07100	583	0.06820	628	0.06190	673	0.01370	718	0.00320	763	0.00080
404	0.00030	449	0.12840	494	0.04730	539	0.07100	584	0.06820	629	0.09160	674	0.01320	719	0.00310	764	0.00080
405	0.00040	450	0.13540	495	0.04860	540	0.07120	585	0.06780	630	0.17380	675	0.01270	720	0.00300	765	0.00080
406	0.00040	451	0.14010	496	0.04980	541	0.07140	586	0.06770	631	0.18410	676	0.01230	721	0.00290	766	0.00080
407	0.00040	452	0.14060	497	0.05100	542	0.07160	587	0.06750	632	0.12410	677	0.01190	722	0.00290	767	0.00070
408	0.00050	453	0.13770	498	0.05210	543	0.07170	588	0.06700	633	0.08320	678	0.01150	723	0.00280	768	0.00070
409	0.00060	454	0.13200	499	0.05350	544	0.07160	589	0.06650	634	0.11220	679	0.01110	724	0.00260	769	0.00070
410	0.00070	455	0.12370	500	0.05440	545	0.07180	590	0.06610	635	0.13690	680	0.01070	725	0.00260	770	0.00070
411	0.00080	456	0.11470	501	0.05550	546	0.07190	591	0.06570	636	0.09600	681	0.01040	726	0.00250	771	0.00060
412	0.00080	457	0.10560	502	0.05670	547	0.07190	592	0.06530	637	0.06010	682	0.01010	727	0.00240	772	0.00060
413	0.00100	458	0.09710	503	0.05770	548	0.07200	593	0.06480	638	0.04420	683	0.00980	728	0.00240	773	0.00060
414	0.00120	459	0.08950	504	0.05860	549	0.07200	594	0.06440	639	0.03820	684	0.00950	729	0.00230	774	0.00060
415	0.00140	460	0.08420	505	0.05950	550	0.07180	595	0.06390	640	0.03550	685	0.00920	730	0.00220	775	0.00060
416	0.00160	461	0.07880	506	0.06040	551	0.07200	596	0.06370	641	0.03400	686	0.00890	731	0.00220	776	0.00060
417	0.00190	462	0.07570	507	0.06130	552	0.07190	597	0.06470	642	0.03280	687	0.00860	732	0.00210	777	0.00050
418	0.00220	463	0.07310	508	0.06180	553	0.07210	598	0.06450	643	0.03210	688	0.00830	733	0.00200	778	0.00050
419	0.00250	464	0.07040	509	0.06260	554	0.07200	599	0.06330	644	0.03160	689	0.00810	734	0.00200	779	0.00060
420	0.00290	465	0.06810	510	0.06310	555	0.07200	600	0.06260	645	0.03180	690	0.00790	735	0.00190	780	0.00050
421	0.00340	466	0.06550	511	0.06380	556	0.07210	601	0.06210	646	0.04020	691	0.00770	736	0.00180		
422	0.00390	467	0.06290	512	0.06450	557	0.07200	602	0.06160	647	0.05460	692	0.00750	737	0.00180		
423	0.00450	468	0.05980	513	0.06510	558	0.07210	603	0.06170	648	0.04800	693	0.00720	738	0.00170		
424	0.00520	469	0.05700	514	0.06550	559	0.07210	604	0.06130	649	0.03630	694	0.00700	739	0.00160		

### UNIFIED GLARE RATING

Reflectances											
Ceiling Cavity	70	70	50	50	30	70	70	50	50	30	
Walls	50	30	50	30	30	50	30	50	30	30	
Floor Cavity	20	20	20	20	20	20	20	20	20	20	
Room Size	UGR Viewed Crosswise					UGR Viewed Endwise					
X=2H	Y=2H	19.6	21.2	20.0	21.5	21.8	20.6	22.2	21.0	22.5	22.8
	3H	21.0	22.4	21.4	22.7	23.1	21.9	23.3	22.2	23.6	24.0
	4H	21.4	22.8	21.8	23.1	23.5	22.3	23.6	22.7	24.0	24.3
	6H	21.7	22.9	22.1	23.3	23.7	22.5	23.8	22.9	24.1	24.5
	8H	21.8	22.9	22.2	23.3	23.7	22.6	23.8	23.0	24.2	24.6
	12H	21.8	22.9	22.2	23.3	23.7	22.6	23.8	23.1	24.1	24.6
4H	2H	20.3	21.6	20.7	22.0	22.4	21.1	22.4	21.5	22.8	23.1
	3H	21.8	23.0	22.3	23.3	23.7	22.5	23.7	23.0	24.1	24.5
	4H	22.4	23.4	22.8	23.8	24.2	23.1	24.1	23.5	24.5	24.9
	6H	22.7	23.6	23.2	24.0	24.5	23.4	24.3	23.9	24.7	25.2
	8H	22.8	23.6	23.3	24.1	24.5	23.5	24.3	24.0	24.8	25.2
	12H	22.9	23.6	23.3	24.1	24.5	23.6	24.3	24.0	24.8	25.2
8H	4H	22.6	23.4	23.1	23.9	24.3	23.2	24.0	23.7	24.5	25.0
	6H	23.0	23.7	23.5	24.2	24.7	23.7	24.3	24.1	24.8	25.3
	8H	23.2	23.8	23.7	24.3	24.8	23.8	24.4	24.3	24.9	25.4
	12H	23.2	23.8	23.7	24.3	24.8	23.9	24.4	24.4	24.9	25.5
12H	4H	22.6	23.3	23.1	23.8	24.3	23.2	24.0	23.7	24.4	24.9
	6H	23.1	23.7	23.6	24.1	24.7	23.7	24.3	24.2	24.8	25.3
	8H	23.2	23.8	23.7	24.2	24.8	23.8	24.4	24.3	24.9	25.4

The UGR values have been calculated according to CIE Publ. 117.

Spacing-to-Height-Ratio = 1.00.

The highlighted value refers to the UGR value which the luminaire would have in a reference situation with room dimensions of 4H/8H and degrees of reflectance of 20% for the floor, 50% for the walls and 70% for the ceiling, as recommended by DLC.

The UGR value may vary depending on application specific parameters.